

FUTURE

ASPIRING

AVIATORS

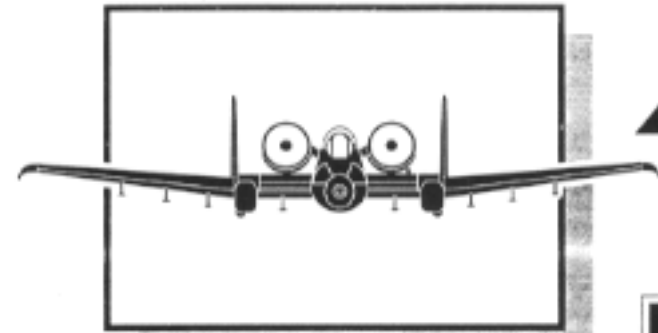

PRIMARY

AN AVIATION CURRICULUM GUIDE

K - 3

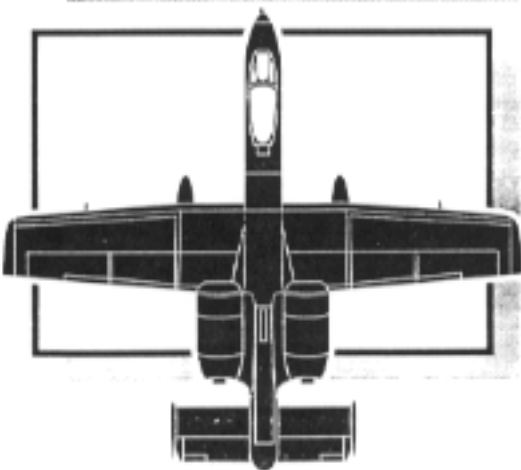
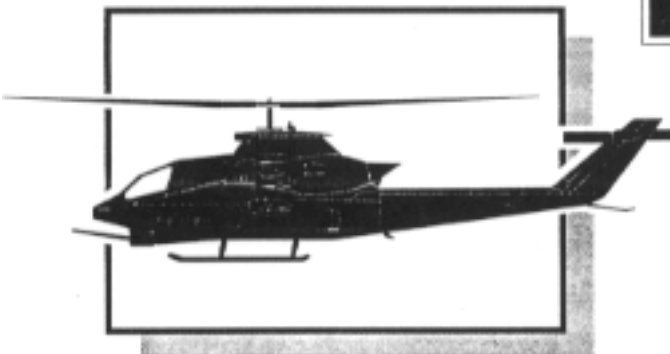

Edited by:

Margaret R. Lindman, Ed.D.

Professor

Northeastern Illinois University

Chicago, Illinois

Department of Transportation

Federal Aviation Administration

Office of Human Resource/Management

Aviation Education Division

Washington, D.C. 20591

TABLE OF CONTENTS

ACKNOWLEDGMENTS.....	iii
FAA AVIATION EDUCATION REPRESENTATIVES.....	iv
STUDY PHOTOGRAPHS.....	v
SELECTED AEROSPACE TOPICS IN CURRICULUM CONTEXT.....	ix
SUGGESTED MATERIALS LIST.....	xi

	<u>Page</u>
I. WEATHER.....	1
Weathering Thoughts.....	2
Trip to the Weather Station.....	4
Weather Station Learning Center.....	5
Pilot Visit/Pilots Study Weather.....	6
Cloud Formation/Go Fly A Kite.....	7
II. GRAVITY.....	9
Up, Up and Away/Down We Go.....	10
Stick Em Up.....	11
Heavy, Heavier and Heaviest.....	12
III. AIR.....	13
Air, Where Is It?.....	14
Air: What Can It Do?.....	15
Its in the Air.....	16
Pressures Rising.....	17
Floating on Air.....	18
Using Air: Drag, Thrust, Gravity, Lift.....	19
Those Funny Forces.....	22
IV. AIRCRAFT.....	24
How High.....	25
A Trip to the Airport.....	27
Airport Corner/It's A Bird - It's A Plane.....	28
Fun with Planes.....	30
Name That Part.....	31
Label Those Parts.....	35
Incredible Flying Machine.....	36
On Our Own/Can You Fit The Shapes.....	37
V. SPACE.....	39
Space Exhibit/Space Learning Center.....	40
Rockets/Space Colony.....	41

VI.	SUPPLEMENTARY ACTIVITIES.....	42
VII.	APPENDIX.....	54

INTRODUCTION

The Federal Aviation Administration is pleased to present the Aviation Education Teacher's Guide Series. The series includes four publications specifically designed as resources to those interested in aviation education. The guides include activities and lessons specifically designed for use in a variety of content areas at various grade levels. It is our hope that the publications in this series will be beneficial to those who lead America's aviation education initiatives into the 21st century.

ACKNOWLEDGMENTS

The Federal Aviation Administration wishes to recognize and express appreciation to Margaret R. Lindman, Ed.D., Northeastern Illinois University, Chicago, Illinois, for her outstanding leadership and dedication to this project. Dr. Lindman served as chair of Northeastern's Department of Curriculum and Instruction while serving as the leader of the project. Rosamand D. Hilton, formerly of the Chicago Public Schools, served as assistance to Dr. Lindman throughout the project.

Roycealee J. Wood, former Director of Academic Affairs, North Chicago, Illinois, School District #187 served on the project writing committee. Faculty members on the committee included Delores Clark, Dorothy Ashby, Ethyl Booker, Ronald Carlson, William Petrosky, Ann Saunders, and Lawrence Sorenson. We wish to thank each of the teachers in North Chicago School District who participated in the field test phase of the project.

Northeastern Illinois University's FAA Publications Committee members were Harvey Barrett, Ed.D., science educator, Janet Bercik, Ed.D., clinical experiences director and elementary and secondary supervisor; Joanne Frey, Ed.D., elementary specialist; Elizabeth Landerholm, Ed.D., early childhood specialist; Jill Althage and Kristine Tardiff, librarians.

Dr. Gordon Lamb, as President of Northeastern Illinois University, was among those who provided crucial support to this project from the very beginning. The Chicago Teacher's Center, a branch of Northeastern's College of Education and an FAA Aviation Education Resource Center, has contributed substantially to the success of the project.

FAA wishes to especially acknowledge the monumental contributions of Mervin K. Strickler, Jr., Ed.D., former Director of FAA's Aviation Education Programs Division. It was Dr. Strickler's leadership that led to the creation of FAA's original FAA Teacher Guides for Aviation Education.

It would have been impossible to complete this project without the professional guidance and assistance of many individuals and organizations. We express our appreciation to the dedication team who contributed to the earlier editions of the aviation education guides as well as the team completing this edition. Their achievements are admirable.

Phillip S. Woodruff
FAA Headquarters
Aviation Education

Federal Aviation Administration Aviation Education Representatives

Federal Aviation Administration

Phillip S. Woodruff, AHR-15
Zelma P. Thomas, AHR-15
Headquarters
Aviation Education Program
800 Independence Avenue, SW
Washington, DC 20591
(202) 267-3788
(202) 267-3850
(202) 267-9508 fax

Aeronautical Center

Robert L Hoppers, AMC-8
Aviation Education Officer
FAA Mike Monroney Aero. Center
PO Box 25082
Oklahoma City, OK 73125
(405) 954-5332
(405) 954-9964 fax

Technical Center

Carleen Genna-Stoltzlus, ACT-110
FAA, William J. Hughes Technical
Center
Atlantic City, NJ 08405
(609) 485-6630
(609) 485-4391 fax

Center for Management Development

Larry D. Hedman, ANM-040
4500 Palm Coast Parkway, SE
Palm Coast, FL 32137
(904) 446-7126
(904) 446-7200 fax

Alaskan Region

Marsha J. Brown, AAL-4
FAA, Aviation Education Office
222 West 7th Avenue, Box 14
Anchorage, AK 99513-7587
(907) 271-5293
(907) 271-4454 fax
STATE: Alaska

Central Region

Maria Z. Navarro, ACE-41F
601 East 12th Street
Kansas City, MO 64106
(816) 426-6547
(816) 426-3124 fax
STATES: Iowa, Kansas, Missouri,
and Nebraska

Eastern Region

Jim Szakmary, AEA-17
JFK International Airport
Federal Building #111
Jamaica, NY 11430
(718) 995-7999
(718) 995-5663 fax
STATES Delaware, District of
Columbia, Maryland, New Jersey,
New York, Pennsylvania, Virginia,
and West Virginia

Great Lakes Region

Lee Carlson, AGL-11
O'Hare Lake Office Center
2300 East Devon Avenue
Des Plaines, IL 60018
(708) 294-7042
(708) 294-7368 fax
STATES: Illinois, Indiana,
Michigan, Minnesota, North Dakota,
Ohio, South Dakota, and Wisconsin

New England Region

Shelia Bauer, ANE-45
12 New England Executive Park
Burlington, MA 01803
(617) 238-7378
(617) 238-7380 fax
STATES: Connecticut, Maine, New
Hampshire, Rhode Island, Vermont,
and Massachusetts

Northwest Mountain Region

Maurice Caldwell, ANM-14A
1601 Lind Avenue, SW
Renton, WA 98055-4056
(206) 227-2081
(206) 227-2199 fax
STATES: Colorado, Idaho,
Montana,
Oregon, Utah, Washington, and
Wyoming

Southern Region

Janice Pope, ASO-17B.1
1701 Columbia Avenue
College Park, GA 30337
(404) 305-5386
(404)305-5311 /5312 fax
STATES: Alabama, Florida,
Georgia, Kentucky, Mississippi,
North Carolina, South Carolina,
Tennessee, Puerto Rico, and the
Virgin Islands

Southwest Region

Debra Myers, ASW-18B
Aviation Education Program
Manager
Federal Aviation Administration
Ft. Worth, TX 76193-0018
(817) 222-5833
(817) 222-5950 fax
STATES: Arkansas, Louisiana, New
Mexico, Oklahoma, and Texas

Western-Pacific Region

Hank Verbais, AWP-17F
PO Box 92007
Worldway Postal Center
Los Angeles, CA 90009
(310) 297-0556
(310) 297-0706 fax
STATES: Arizona, California,
Nevada, and Hawaii

Bi-Wing Plane



The Biplane has two wings. One at the top of the fuselage (body of the plane) and one below it. Struts attach one wing to the other. This support makes the wings strong but the drag on the plane is increased and therefore, the plane flies more slowly than other types of planes.

Jet Plane



The jet plane can be identified by its compact engines that do not have propellers. The jet engine works by burning a mixture of fuel and air in a combustion chamber that produces a jet of hot gas which produces thrust. These planes can fly very high and fast. Sometimes they leave trails across the sky which looks like two very long white clouds. These are called contrails.

Helicopter



Helicopters do not have wings like most other airplanes. They have rotating blades above the body of the plane. The blades provide for lift, propulsion and steering of the helicopter. Helicopters can take off vertically rising right straight up in the air. They can hover (remain in one spot in the air) and fly in any direction. Helicopters have a tail rotor (like a small propeller in a more vertical position) to prevent the helicopter body from spinning around and around.

Passenger Plane



This passenger plane is a modern jetliner. It has not propellers because power comes from the turbofan jet engines. Some "jumbo jets" can fly 400 passengers for more than 8,000 miles without having to refuel. They fly very high where they can save on fuel and avoid most bad weather.

SELECTED AEROSPACE TOPICS IN CURRICULUM CONTEXT

Often educators who teach about aviation and space education are challenged by administrators, other teachers and parents who question the validity of such study. The following list indicates just some of the specific ways this topic interrelates with traditional studies.

Where they fly is GEOGRAPHY

Who made them fly is HISTORY

How they fly is SCIENCE

Where they land is SOCIAL STUDIES

ART

Balloons
Commemorative stamps and medals
History of aviation
Insignia
Interiors of aircraft
Kites
Medals and decorations
Model aircraft
Mythology
Objects of art
Photography
Pilot and crew wings
Science fiction

ASTRONOMY

Asteroids
Astronautics
Astronomy
Comets
Constellations
Eclipse
Galaxies
Light
Meteors
Moon
Observations
Planetariums
Planets

Stars
Sun
Telescopes
Universe

BIOLOGY

Animals in space
Bird Flight
Closed ecological system
Photosynthesis

CAREER GUIDANCE

Air traffic control
Astronauts
Careers
Charter flying
Flight attendant
Flight instruction
General aviation
Ground service and maintenance
Occupations
Pilot training
Spacecraft design
Test pilots
Women in aerospace

CHEMISTRY

Air

Atmosphere
Gases
Specific gravity

EARTH SCIENCE

Air masses
Astronomy
Atmosphere
Aurora
Aviation weather
Charts
Compasses
Earth
Gravity
Lightning
Maps and Mapping
Precipitation
Weather
Weather maps and charts
Weather satellites

GENERAL SCIENCE

Airplane
Astronomy
Atmosphere
Atoms
Barometric pressure
Bird flight
Clouds
Electricity

GENERAL SCIENCE
(contd.)

Energy
Fog
Galaxies
Helicopters
Jet aircraft
Launch vehicles
Man in flight
Photography
Planets
Radio communications
Satellites
Saturn rockets
Space stations
Starts
Sun
Walk in space
Weather
Weather satellites

GEOGRAPHY

Charts
Compasses
Course plotting
Latitude and longitude
Maps and mapping
Photography

HEALTH

Animals in space
Astronauts
Flight physical
Food and nutrition
Life-support systems
Man in flight
Manned spaceflight
Man-powered flight
Pressurization
Spacesuits
Temperature control
Weightlessness

HISTORY

Ace
Balloons
Biographies
Commemorative stamps
and medals

Dirigibles
Gliders
History of aviation
Man-powered flight
Mythology
Science fiction
Women in aerospace

MATHEMATICS

Dead reckoning
Information systems
Navigation techniques
Orbits and trajectories
Weight and balance

METEOROLOGY

Air
Air masses
Atmosphere
Barometric pressure
Clouds
Earth Science
Evaporation and
condensation
Fog
Humidity
Precipitation
Turbulence
Weather maps and charts
Weather satellites
Wind

PHYSICS

Airplane
Center of gravity
Computers
Electricity
Energy
Engines
Gyroscope
Instrument panel
Launching
Matter
Noise
Nuclear energy
Radio
Robots
Sail planes
Supersonic flight

Television
Wings

SOCIAL STUDIES

Airmail
Air taxis
Biographies
Careers
Cargo aircraft
Commercial airlines
Communications
satellites
Flight (as passenger)
Flight test programs
General aviation
Gliders
Gliding
Hangars
Helicopters
Heliports
History of aviation
Jet aircraft
Jumbo jets
Kennedy Space Center
Launch facilities
Launch vehicles
Lunar base
Lunar exploration
Missiles
Mythology
NASA
Rescue and recovery service
Runways
Space stations

SPEECH AND
COMMUNICATIONS

Phonetic alphabet
Terminology of
aerospace

SUGGESTED MATERIALS LIST

Graph paper	Marbles
Pictures of rockets	Rubber bands
Crayons	Umbrella
Scissors	Aluminum foil
Different sized balls	Pictures showing gravity at work
Pencils	Very long elastic strips or inner tubing
Glue or paste	Shelf plastic
Large long paper sheets	Marker
Weather symbol cut outs	Scale
Glass	Materials of different weights
Liquid (water)	Hooks
Pictures-planes and birds in flight	Kite sticks
Plastic Sandwich bags	Bottles
Twist ties	Hot plate
Garbage bags	Wooden matches
Straws	Glass pill bottles
Large jars	Corks
Large containers	Vaseline
Perfume	Magnifying glasses
Balance scale	Cans
Cotton balls and strongly scented materials	Staplers
Textbooks	Plastic bottles
Cardboard	Wood
Dish pan	Wire
Balloons	Paper clips
Kite material (sticks, paper, glue, long strip of cloth and string)	Model planes
Fan	Paints
Small objects which can be tied to strings	Scotch tape
Buckets	Feathers
Small flags	Construction Paper
Clip board	Cloth or handkerchiefs
Books on airports and airplanes	String
Index cards	Balls
Ping pong balls	Paper clips
Ruler	Scrap paper
Rock	
Jump rope	

UNIT I.

WEATHER

Weather is important to a pilot. Fog can affect visibility. Ice can interfere with the smooth operation of the mechanical parts of the airplane. Wind and rain can produce turbulence that can cause the airplane to toss and turn. Therefore, it is important for the pilot to try to avoid weather problems. Many airplanes have very excellent instruments that assist the pilot in understanding and interpreting the weather conditions and how they affect the flight.

"WEATHERING" THOUGHTS

Objectives: To introduce collecting and recording data with a pictograph using observations and inferential skills.

Materials: Large month-long calendar; weather symbol cut outs; large sheets of paper for two graphs; 8 x 10 sheets of paper for each child to make paper airplane; glue/paste.

Teacher Info: Label the first graph as follows. Show the number of days on the left side and five columns across for RAINY, SNOWY, SUNNY, CLOUDY, and WINDY. The second graph should contain the number of days on the left side and two columns across for "FLYING TODAY" and "NO FLYING TODAY".

Skills: Collecting and recording data; inferring; group consensus.

Time: 45 minutes initially; approximately 10 minutes per day.

Instructional Methods:

- 1) Have the children make simple paper airplanes using the 8 x 10 sheets of paper as depicted. Let them fly their planes inside when they are done. Discuss safety first. Discuss what would happen to planes various types of weather if flown out of doors.
- 2) Show the children the weather symbol cut outs. Explain that the class will have to decide on one shape for each day. Have the students make their first thoughts for weather symbol. Put the appropriate symbol on the calendar with glue or paste. Choose one student to color the appropriate square on the first graph. Then, based on current weather conditions, decide if it would be a good day to fly their paper planes. Explain why or why not. Color appropriate square on second chart.
- 3) Using the large month-long calendar and the two graphs, chart the weather on a daily basis. Decide whether it's a good day to fly the paper plane outside. What have you noticed about today's weather? What did you notice yesterday? What are the similarities and differences? What could happen outside that would make it a good day to fly? What would make it a bad day to fly?
- 4) Tally the various weather days along with the flying and no flying days. This can be done for one month of each season of the school year.

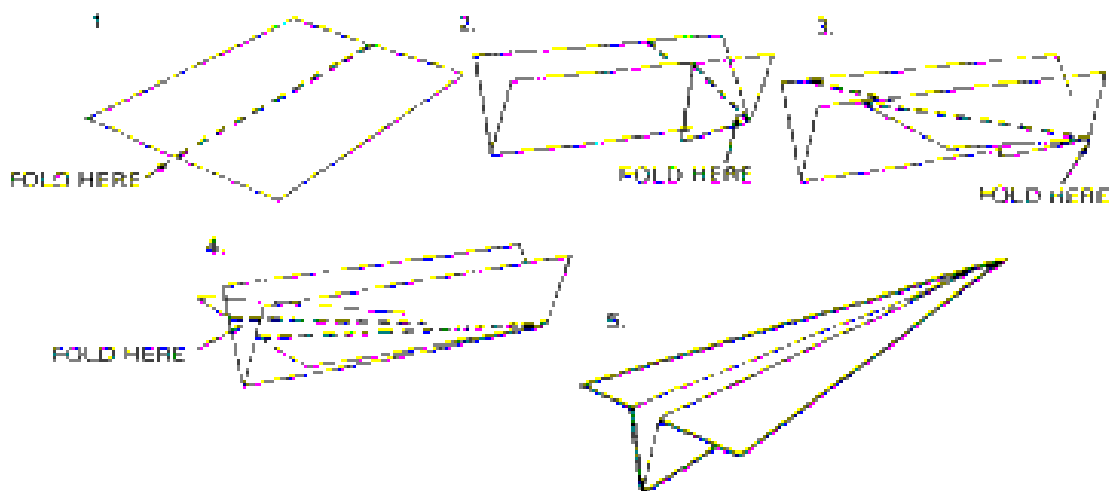

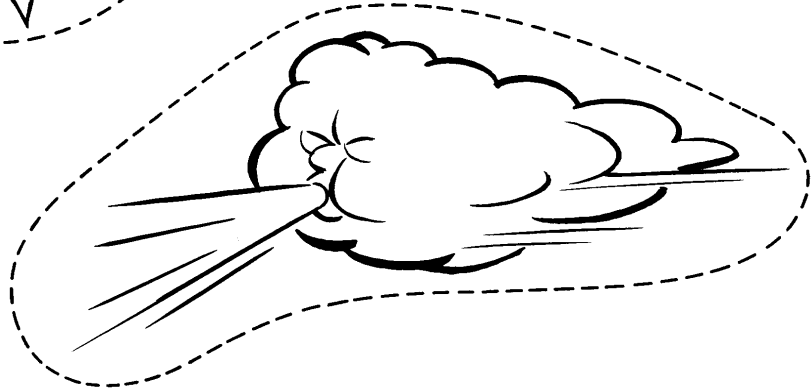
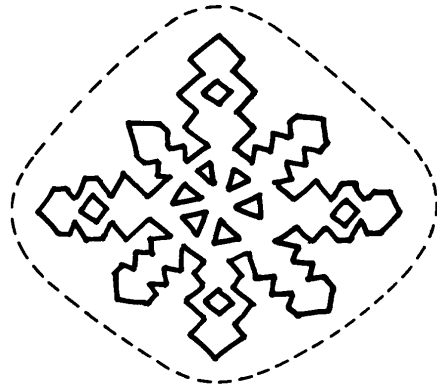
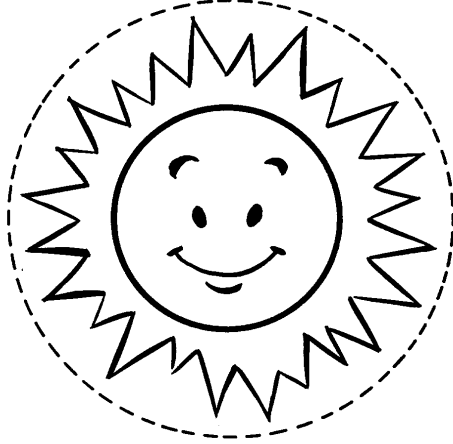
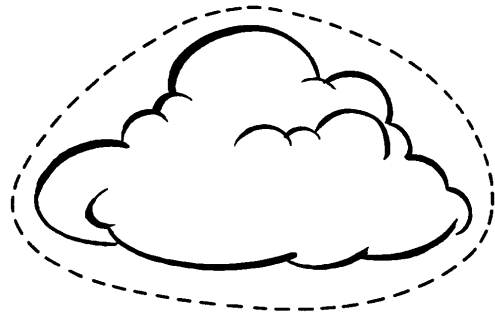

Trip to the Weather Station

Objectives: To see how weather information is collected and disseminated. To list 4 kinds of weather information that are gathered.

Skills: Observing, measuring, gathering data, expanding weather vocabulary.

Materials: Field trip. Many communities have a small local recording weather station. It may be found in a public building or school. Most airports have weather stations. For the locations of weather stations in your area, contact the United States Weather Bureau, a division of The National Oceanic and Atmospheric Administration (NOAA).

Time: Variable, depends on proximity to weather station.

Instructional Methods:

- 1) Discuss with students the effect of gathering good weather information for flying.
- 2) Introduce vocabulary relating to the weather station.
- 3) Call weather station, arrange for person who gathers weather data to explain to students about their job.
- 4) Take students to weather station.

Follow-up Activities: (See Weather Station Learning Center Activity).

Weather Station Learning Center

- Objectives:** To role play observing and collecting weather information.
- Materials/Set Up:** Set up dramatic play corner as a weather desk for pilots to get weather information before flying. Set up a weather vane or wind sock outside a window which can be seen from the classroom to see wind direction. Weather desk - The weather person needs to convey to pilot the direction of the wind (from the vane) the speed of the wind from the wind sock (the closer the wind sock is parallel with the ground, the higher the wind velocity/speed), and the visibility, (how far can child see distant landmarks out the window). If possible, obtain a small battery operated weather radio which gives a continuous forecast to the weather person. Have a play phone available for calling about the weather. Construct a weather information display board with dials drawn in to simulate information at a real weather center. Have pilot hats available for pilots to wear.
- Skills:** Observing wind velocity, direction and visibility. Role play concepts of weather station.
- Time:** During free choice
- Instructional Methods:**
- 1) Allow children to role play pilots coming to the weather desk to find out the weather.
 - 2) Children could choose this activity during free choice time.
- Extension:** Wind socks are now being used as decorative items. They can be made by taking a large piece of colored paper (18" x 24") decorating it and bending it into a cylinder. Strips (2' X 24") long) of crepe paper are attached to the bottom of the cylinder. Decorations can be thematic, i.e., fall, Halloween, winter, animal faces, etc.

Pilot Visit

Objectives: To describe a pilot's occupational duties.

Materials: A community member whose occupation is a pilot. (Contact local Civil Air Control)

Skills: Listening

Time: 40 minutes.

Instructional Methods::

Guest speaker (pilot) will talk to students about his job as a pilot.

Pilots Study Weather

Objectives: To list good and bad weather conditions for flying. To discuss how poor visibility affects the pilot.

Materials: Goggles smeared with Vaseline, paper for airplanes, buckets, chair.

Skills: Classifying, listening, vocabulary.

Time: Forty minutes.

Instructional Methods:

- 1) Students will throw a paper airplane into a bucket.
- 2) Students will wear goggles smeared with Vaseline and try to launch a paper airplane into a bucket. Students will sit in a chair being rocked from side to side and back and forth by the teacher or another student and try to launch a paper airplane into a bucket.
- 3) Students will wear goggles and sit in a rocking chair and try to throw a paper airplane into a bucket.
- 4) Students will discuss the effects of poor visibility and high winds on the ability of a pilot to land an airplane.

CLOUD FORMATION

Objectives: To describe cloud types, weather associated with various cloud formations.

Materials: Chart PUB E.S. (See Publications Appendix p 59) Cloud Recognition)

Skills: Observing, describing, matching.

Time: 40 minutes.

Instructional Methods:

- 1) Students will study charts together in small groups.
- 2) Students will draw pictures of the various cloud types and make a lotto game.
- 3) Students will play lotto game, matching the cloud types.

"GO FLY A KITE"

Objectives: To practice gathering and interpreting data relative to flight; to discover the principles of balance and lift relative to kite flying.

Materials: String, glue, tape, kite sticks, paper or plastic, worksheets

Skills: Gathering and interpreting data; identifying variables.

Time: 40 minutes

Instructional Methods:

- 1) Demonstrate kite construction (p 9). Have students construct kites.
- 2) Use any of the following approaches to explore variables affecting kite flying.
 - Measure how quickly several kites reach a given altitude. Which climb the fastest?
 - Is a tail needed during different weather conditions?
 - Graph the results attitude vs. speed. Is there one overall best design?

NOTE: PLEASE REMEMBER: Never use wire for kite "string". Never climb utility poles to retrieve a kite. Never fly kites during electrical storms.

"GO FLY A KITE"

FLAT KITE

MATERIALS: string
glue
tape
kite sticks
paper or plastic

- PROCEDURE:**
1. A flat kite may be constructed by securing sticks in the manner shown and attach to paper or plastic.
 2. Attach a string from the end of each spar to the end of each keel.
 3. Cover the frame with glue or tape.
 4. Attach the bridle and flying line.

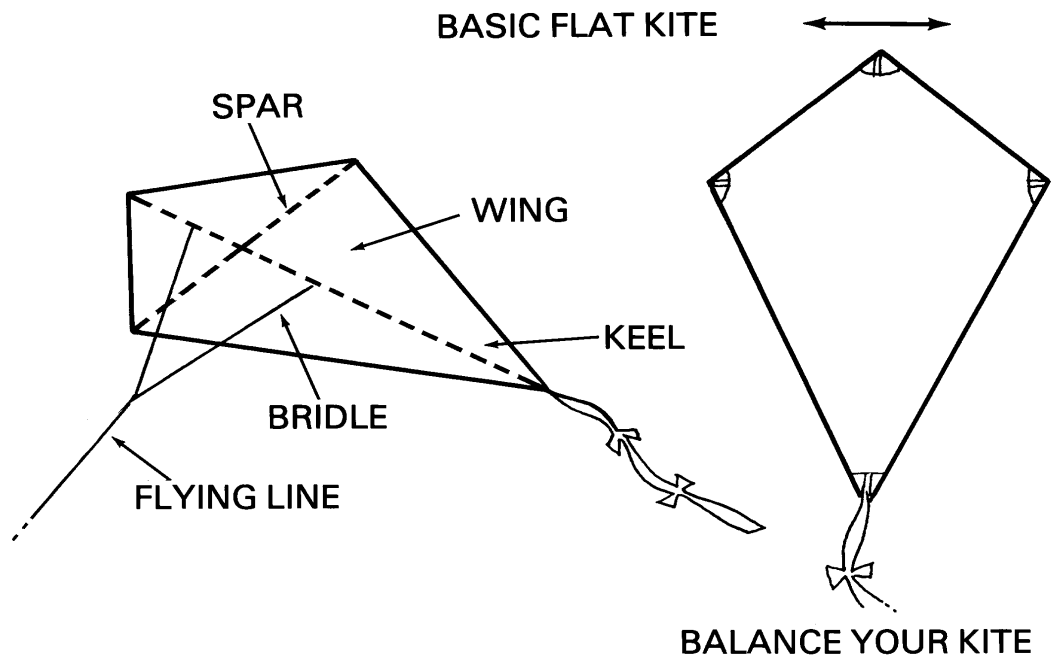

UNIT II.

GRAVITY

Gravity is a force that is very important in airplane flight. It is a force that pulls objects toward the earth. In order to pull away from the earth, the pilot must be able to overcome that pull by using speed or thrust from engines and lift from the wings.

UP, UP, AND AWAY

Objectives: To introduce the concept of up and down; enhance group discussion skills.

Materials: Outdoor activity: balls of various sizes

Skills: Observing.

Time: 30 minutes.

Instructional Methods:

- 1) On the playground, have the children play catch with balls. Try different types of balls: Nerf balls, basketballs, volleyballs, baseballs. Do they all go up? Do they all come down? Do some go up and down faster? Slower?
- 2) From the top of a slide or balcony drop different objects. Do they all fall down?
- 3) Observe which items fall faster? Why?

DOWN WE GO!

Objectives: To introduce the concept of gravity; to observe the effects of gravity.

Materials: Different sized balls.

Skills: Observation, experimentation and inference development.

Time: 45 minutes.

Instructional Methods:

- 1) Take two balls of different sizes, one large and one small. Give the balls to two students. Have one of them stand on a chair and the other sit on the floor to observe when the balls hit the floor. Tell the first students to drop both balls at the same time. Do the balls land at the same time? Encourage the students to explain why.
- 2) Discuss when gravity is a negative force. (An apple falls on our heads. A plane has to work quite hard to become free of the earth, etc.) Discuss how gravity is a positive force. (Things stay where they are.)
- 3) Ask the students if they have ever seen pictures on TV of astronauts floating in the capsules. Have students try to float like an astronaut. Can they do it? Discuss. The power of gravity is greatly decreased in outer space, allowing astronauts to float freely.

STICK EM UP

Objective: To observe that objects fly only when the force of upward air (resistance) is greater than the force of downward gravity.

Materials: Balloon, kite materials (2 sticks, paper, glue, long strip of cloth, string), fan, parachute, feather, paper, pencil.

Skills: Observing, inferring

Time: 45 minutes.

Instructional Methods:

- 1) Have students recall what they have seen flying or floating in the air. (Example leaves, seeds, balloons).

NOTE: Discuss the idea that gravity is continuously working to keep things on the earth. Objects can only fly when the force of air upward is greater than the gravitational force.

- 2) Fill a balloon with air. Discuss whether or not the balloon will rise. Let the balloon go. Note what happens. Try to keep the balloon up by blowing on the bottom of it with a fan. What happens now?

- 3) Make a kite (or purchase one). Take the students outside to fly it.

NOTE: The wind's pressure has a tendency to keep the kite up in the air, while gravity tends to pull it down. The flyer must hold the kite at an angle for the air to strike against the under surface of the kite. The tail keeps the kite upright. The flyer uses the string to keep the kite windward.

- 4) Attach a feather onto the parachute. Note its rate of descent. Now drop the feather by itself. Note its rate of descent. Which fell to the ground faster? Use other items, such as a piece of paper, a pencil, etc. Observe the difference of falling objects.

Note: The parachute slows down falling objects by "capturing" air. However, not enough pressure is created to keep the objects up.

HEAVY, HEAVIER AND HEAVIEST

Objectives: To use weight as a means of measuring gravitational pull; to demonstrate the relationship between gravity and flying; to demonstrate that a spring scale measures the gravitational pull of an object.

Materials: Pictures showing gravity at work; very strong elastic; shelf paper; marker; scale; various materials of different weights; bucket; hook.

Skills: Observing, recording data, predicting, comparing.

Time: 45 minutes.

Instructional Methods:

- 1) Discuss children's concept of gravity. Drop an object on the floor. Ask students what they notice and why it happened. Pour some liquid in a glass. Ask why it doesn't fly out the open top.
- 2) Display pictures of gravity at work (bicycling, people sitting, liquids poured into different containers, etc). Discuss what's happening in the pictures and why.
- 3) Discuss what they might do on the moon that would be difficult for them to do on earth.
- 4) Using these steps, make a spring scale. Hang a longsheet of shelf paper on the wall. Attach a large hook at the top. Collect several different materials of varying weights, such as sand, chalk, cotton, etc. Tie a strip of very strong elastic or inner tubing around the handle of the bucket. Hang on the hook. Student prints a "0" to measure an empty bucket. Begin dropping other materials into the bucket. Record weights.

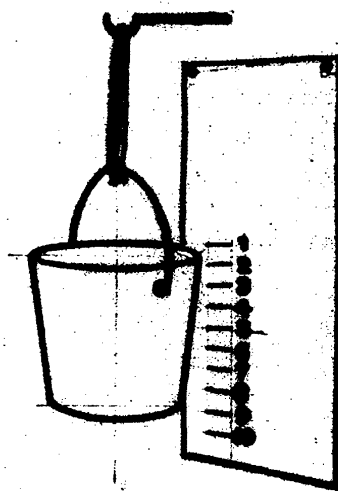

GROUP 1 - 24

UNIT III

AIR

Air is all around us even though we cannot see it. It covers our entire Earth in a layer several hundred miles thick, but 90% of air is concentrated in the lowest ten miles. This bottom layer contains oxygen as well as other gases. Life on our planet needs oxygen to survive. The experiments in this Unit will involve several properties of our invisible air.

AIR - WHERE IS IT?

Objectives: To learn that air has many properties; to understand that although air is invisible, it can be observed.

Materials: Plastic sandwich bags, twist ties, garbage bags, straws, large jar, soda bottles, balance scale, large container of water, liquid bubble soap, balloons, notebook paper.

Skills: Observing, experimenting, inferring.

Time: 60 minutes.

Instructional Methods:

- 1) Ask students to catch some air in a plastic sandwich bag by holding the mouth of the bag open and swishing it through the air. Quickly close the mouth, twist the bag, and secure with a fastener. Students squeeze the trapped air and notice how it feels. Look through the bag filled with air -- Can you see through it? Children can then smell the air by opening the bag a bit. Do the above procedures with outside air. Note their similarities and differences.
- 2) Have the students submerge an empty soda bottle, top up, into a large container of water. Observe what happens.
- 3) Blow up two balloons equally and tie. Attach each balloon to the balance scale and notice that it balances. Prick one balloon with a pin. Notice what happens as the air rushes out. Discuss weight as a property of air indicating its existence.
- 4) Tell the students to relax and close their eyes. Explain that you are making a surprise for them out of air, which they will be able to see when they open their eyes. Blow as many soap bubbles as you can for a few moments, then have the students open their eyes. Ask them what's in the bubbles? What's outside them? Is air all around them?
- 5) Blow up a balloon and put it under water. Release the air slowly under the water.
- 6) Assist students in making their own paper fans. Be sure they understand that by fanning themselves they are making the air move, and therefore, can feel the air.
- 7) Explain to the students that we cannot see air, but we can see what air does to things around us. Ask students how they can tell that air is present.

AIR: WHAT CAN IT DO?

Objective: To observe that air supports things.

Materials: Large plastic bags, rubber bands or twist ties.

Skills: Observing, inferring, experimenting

Time: 15 minutes

Instructional Methods:

- 1) Hand out one large bag to each group of children. Let them practice swishing the bag through the air to fill it. This will take some practice because of its large size.
- 2) As soon as each bag is filled, let someone in the group twist the opening shut, and keep twisting until the bag is no longer limp. Then the twisted part should be doubled over and fastened with a rubber band or twist tie.
- 3) Let the children take turns trying to sit on the bag to see if it will hold them off the ground.
- 4) After sitting on air and feeling the push of the bag against them, children can be encouraged to think about, observe, and describe the action of air on other objects such as a kite or bird.

IT'S IN THE AIR

Objectives: To observe the air flow in a room using indirect evidence.

Materials: Cotton balls soaked in strongly scented materials, paper for fan.

Skills: Observation, inference, drawing conclusions

Time: 30 minutes

Instructional Methods:

- 1) Put scents on numerous cotton balls. Ask the students to raise their hands as soon as they smell the scent. Time this. Do the same thing again, only attach the cotton balls to the fan. Time. Make a comparison.
- 2) Have the students make a fan. Wave it in the air. Does the odor travel faster through the room? Explain air currents if the students can't conclude that air moves.
- 3) Students observe the movement of leaves on trees, clouds, trash blowing, snow blowing, smoke from chimneys, etc. Notice other indicators of air in motion.
- 4) Brainstorm different ways to make air currents detectors: pinwheels, wind socks, soap bubbles in the air, etc. Create some detectors for use in warm and cold places, high and low places, indoors and outdoors, in calm and windy weather, etc.

PRESSURE'S RISING

Objectives: To observe and conclude that air can exert pushing force:

Materials: Plastic drinking straws, plastic sandwich bags, light weight books, water glass, water, a square (6") piece of thin, flat cardboard, plastic dish pan, match box cars.

Skills: Observation, drawing conclusions, experimentation.

Time: 45 minutes

Instructional Methods:

- 1) Give each participant a straw, bag, and a light weight book. Ask student to elevate the book using only the above materials.

***NOTE:** The book can be raised by placing the plastic bag under the book and blowing air into the bag with the straw. Find further evidence of air pressure being used to elevate objects.

- 2) Have a relay race between two teams. A member from each team blows in a sandwich bag with a straw. When the bag expands, and pushes against the car, the car moves. Then deflate the bag and blow again to push car. First car to the end wins. (Note: make it a short distance.)
- 3) Fill a glass with water. Place cardboard over the glass. **CAREFULLY** flip the glass upside down over the dish pan, insuring a secure hold of the cardboard against the glass. Remove your hand. (The cardboard should stay in place.)
- 4) Take two plungers of the kind that are used to force water through drains. Thoroughly wet both plungers and push them together. Have the students try to pull them apart.

FLOATING ON AIR

Objectives: To construct and compare the effects of different parachutes on the speed of falling objects.

Materials: Cloth or handkerchiefs or coffee filters of different sizes, string, small objects which can be tied to the string (EX: erasers, tiny toys, pencils).

Skills: Constructing, collecting data, hypothesizing

Time: 45 minutes

Instructional Methods:

- 1) Secure the four corners of the cloth with string. Attach one of the objects to the string. Drop two similar objects from the same height -- one with a parachute, the other without a parachute. Observe which objects fell to the ground first. Do the above procedure using two different sized parachutes. Which falls first?

NOTE: Discuss the role the parachute plays in the safety of a person jumping from a planeor in the recovery of a space capsule.

- 2) Using the above procedure, try different shapes and quantities of parabutes. Note the difference of descent rates.

USING AIR: DRAG, THRUST, GRAVITY, LIFT

Objectives: To discuss the concept of drag, thrust, gravity and lift.

Skills: Observing, measuring, experimenting.

Time: Four 40 minute periods

DRAG:

Materials: Large sheet of lightweight cardboard, umbrella, 2 identical sheets of paper, aluminum foil marble.

Instructional Methods:

- 1) Have students run with a large square of lightweight cardboard held flat against the wind. Repeat with the edge against the wind. Observe the difference in the amount of resistance.
- 2) Give student volunteer a closed umbrella. Have her/him hold the umbrella behind them and run. Observe the amount of drag on the umbrella. Open the umbrella. Hold it behind and run quickly. How does the amount of drag change? Why does this happen?
- 3) At the same time, drop two identical sheets of paper - one flat, one crumpled. Observe the effect of air resistance on the rate of fall. Why?

THRUST

Materials: Fan, small wagon, balloons, lightweight toy.

Instructional Methods:

- 1) Place a fan in a small wagon. Ask students to notice the movement of the wagon when the fan is turned on. What direction does the wagon move?
- 2) Have students blow up balloons and hold the opening tightly closed. Ask them to release their hold on the opening and notice what the air feels like on their hand as the balloon is released. What direction does the air move in? Why, when it has released all its air, does it fall? What makes the balloon go?
- 3) Fasten an inflated balloon to a small, lightweight toy so that when air is released, the toy will move forward. In what direction is the air moving?

GRAVITY:

Materials: Pencil, rock, ball, jump rope, paper clip, ruler

Instructional Methods:

- 1) Ask, one of your students to jump into the air and stay there. Discuss why she or he can't do that. Discuss what would happen without gravity.
- 2) Drop a pencil, rock and a ball. Discuss why they come down.
- 3) Have a student jump rope. Discuss why the rope can be "turned."
- 4) Compare the speed of two falling objects of identical size and shape, but different weight.

LIFT:

Materials: Sheets of paper, books, drawing of air-flow over and under airplane wing, strong, 2 ping-pong balls, rulers and index card.

Instructional Methods:

- 1) Prepare a bulletin board showing how air flows over and around an airplane wing. Use for reference.
- 2) Have students hold a piece of paper just below the lower lip. Ask them to blow across the top and observe that the paper rises as the pressure on the top of the paper is reduced by the movement of the air.
- 3) Suspend a length of paper loosely between two piles of books. Blow across the top of the paper. What happens?
- 4) Suspend two sheets of paper about 2.5 cm (1") apart between two stacks of books. Blow between the sheets of paper. Notice what happens. (Papers come together.)

Additional Discussions:

Discuss with students the notion that people had to wait until they could design an aircraft with sufficient power, lift and stability before a heavier-than-air craft could be developed. Discuss the four forces that act upon a plane flying in the atmosphere: Lift, gravity, thrust, and drag, and use the worksheet with the explanations on it for reference.

LIFT is an upward force that acts against gravity because of a partial vacuum created above the surface of an airplane's wing causing the wing to be "lifted" upward.

Lift is produced by (a) the difference in the speed of air flowing over the wing surfaces and (b) the angle of attack.

Thrust may be produced by engine-driven propellers, jets or rockets

THRUST is a force created by a power source which gives an airplane forward motion.

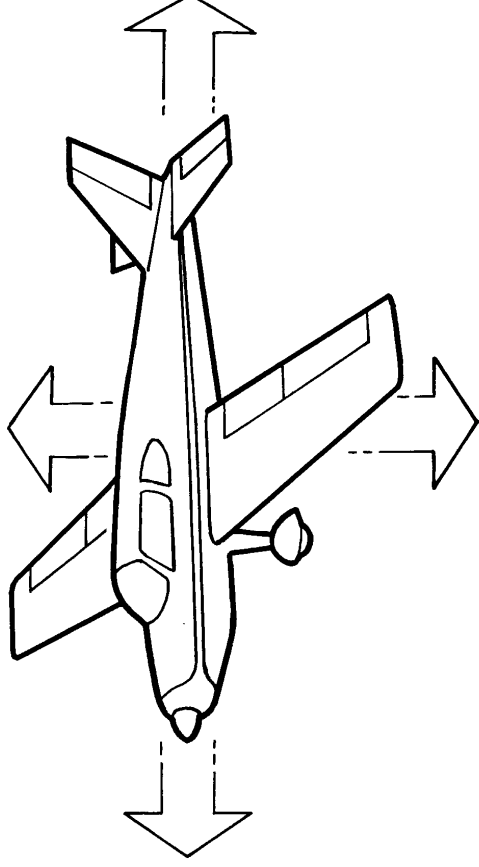

DRAG is the resistance the air offers because of friction which slows the forward movement of an airplane through the air. It is a backward force that works against thrust.

Drag may be reduced by streamlining the shape of the plane.

GRAVITY is a force which pulls downward on the plane.

The weight of the airplane is produced by the attraction of gravity.

THE FORCES INVOLVED IN FLYING A PLANE

THOSE FUNNY FORCES!!

Objectives: To identify forces involved in flying a plane: thrust, drag, lift, gravity.

Materials: Worksheet next page

Skills: Recalling

Time: Open

Instructional Methods:

- 1) Review definition for thrust, drag, lift, and gravity.
- 2) Use the worksheet as an evaluational tool.

ANSWER KEY For Worksheet (page 24)

1 - Drag

8 - Drag

2 - Thrust

9 - Thrust

3 - Thrust

10 - Gravity

4 - Drag

11 - Lift

5 - Gravity

12 - Drag

6 - Lift

13 - Thrust

7 - Drag

14 - Drag

FORCES INVOLVED IN FLYING A PLANE

Which word fits the blank, choose from:

LIFT
THRUST

DRAG
GRAVITY

1. The forward movement of the plane is slowed down by _____.
2. An airplane gets its forward motion from _____.
3. Jets or rockets can produce _____.
4. The resistance the air offers is called _____.
5. A downward force is _____.
6. An upward force is _____.
7. Friction results from _____.
8. A backward force is _____.
9. A power source is created by _____.
10. The weight of the plane is caused by _____.
11. The force that acts against gravity is _____.
12. The force that works against thrust is _____.
13. Propellers produce _____.
14. The difference in air speed over the wing surfaces produces _____.

UNIT IV

AIRCRAFT

The flight of birds of all kinds, as well as insects, caught the eye of men long ago. They watched birds gracefully soar and float through the air and desire to fly too.

It took many generations before man could successfully imitate the flight of birds. Leonardo da Vinci designed several flying machines but never made a working model. Many other men designed and built machines that could fly, but could not sustain flight.

In 1903 at Kitty Hawk, North Carolina, the Wright brothers built and designed their own engine and glider which could carry a man in full flight. They had succeeded. They used the lifting effect of wind on curved wings.

Today, military aircraft exceed 2000 miles per hour. Other aircraft cross the United States in less than four hours.

Many types of aircraft are available today. They are always of great interest to youngsters and grown-ups. Visits to airports are exciting for everyone - and also learning about and identifying aircraft and spacecraft. The units about "aircraft" are only a beginning, but may lead to a lifelong interest.

HOW HIGH???

Objectives: To improve observation and classification skills.

Materials: Worksheets

Skills: Observation, classification, and recalling

Time: 3 class periods. Two field trips and classroom follow-up activities.

Instructional Methods:

- 1) Trip to a museum or airport to look at airplanes.
- 2) Take a walk outside. See if the children can find any objects from nature that are flying.
- 3) Duplicate the worksheet. Discuss the various pictures. Ask for similarities and differences. Are they ALL alike? Are they all different?
- 4) Classifying the pictures into two categories: those objects found in nature and man made objects.
- 5) After looking at the pictures, have the children cut out man made flying objects and flying objects from nature magazines. Make a lotto game.

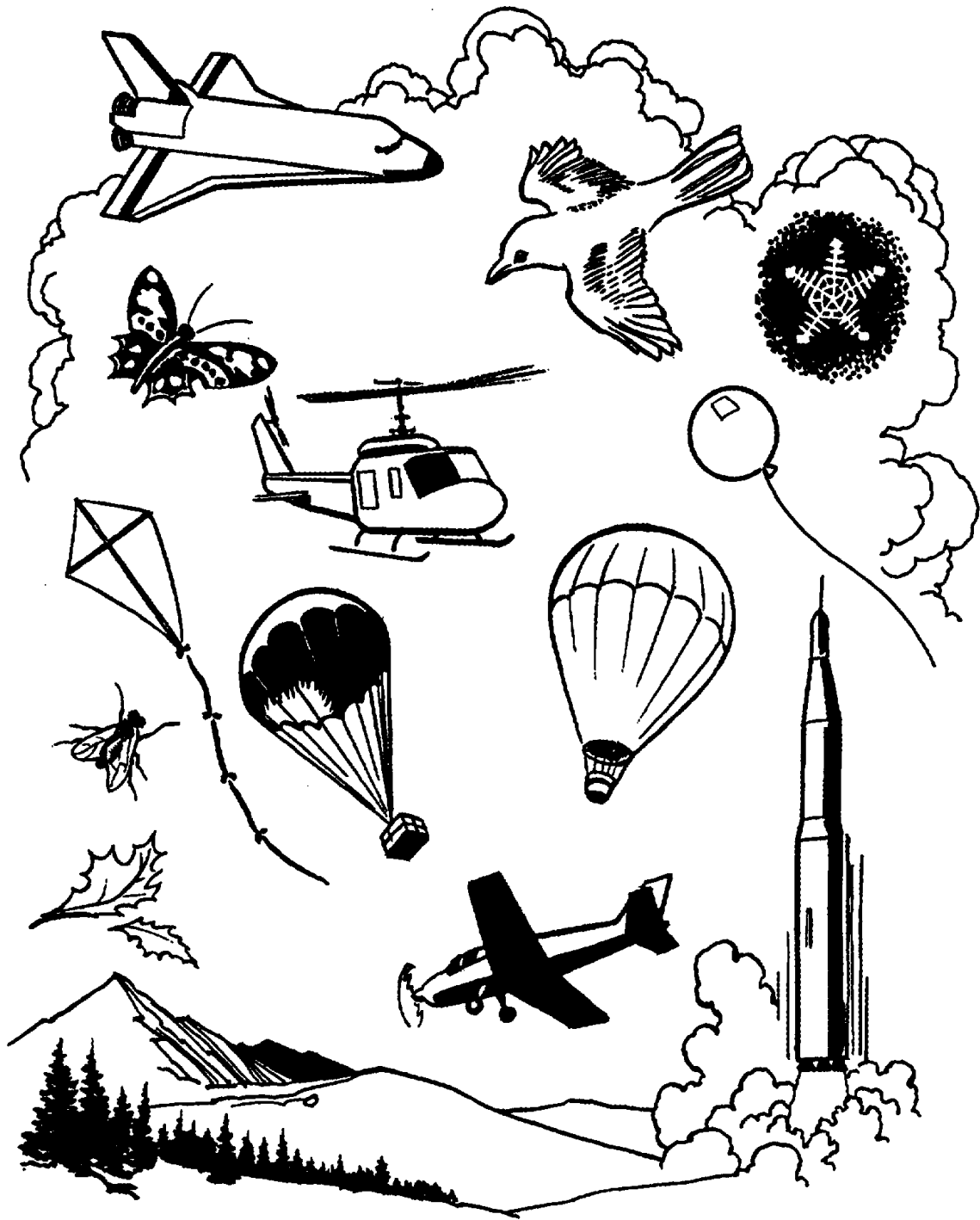

A TRIP TO THE AIRPORT

Objectives: To observe that the airport is a system composed of sub-systems involving a variety of jobs. To point out the parts of the airplanes.

Materials: Books on airports and airplanes.

Skills: Observing, participating, and investigating.

Time: Field trip

Instructional Methods:

- 1) Discuss: Ask if they've ever been to an airport. What did they see? What would they like to know? Create a semantic web*.
- 2) Discuss various things to be seen on the tour:
 - a) People working at many different jobs
 - b) Various sizes of planes
 - c) The control tower
 - d) A hanger
 - e) Runways
 - f) The terminal

* A semantic web is a visual record of a brainstorming session where all children are encouraged to contribute words related to a particular topic which is written in a circle in the middle of the board. Description words are written on the perimeter of the circle.

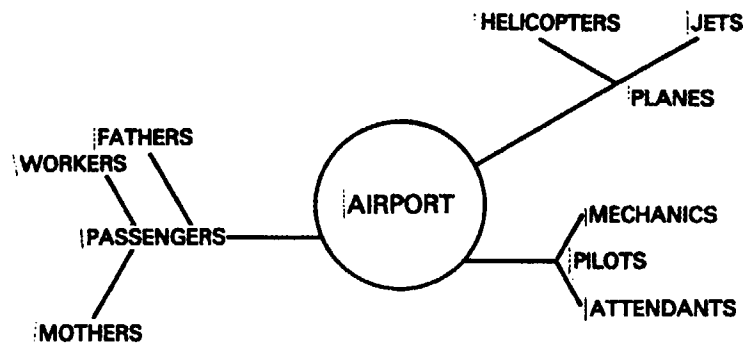

AIRPORT CORNER

Objectives: To role play airport activities.

Materials: Develop an airport corner. Have old baggage/suitcases, baggage tickets, airplane tickets, pilot hats, steward/stewardess uniforms, a large posterboard with dials on it for airplane controls, trays and play food and plates for steward/stewardess to serve, chairs for plane seats.

Skills: Role playing, observing, expanding vocabulary

Time: Use during free choice for duration of the unit.

Instructional Methods:

- 1) Before using corner, visit the airport and read stories about airports.
- 2) Let 4-5 children use the airport corner at one time during free choice period.
- 3) Have children draw pictures and write stories about airplane travel.
- 4) Take photos of the children in the airport corner. Write a class experience story.

IT'S A BIRD ... IT'S A PLANE!!

Objectives: To observe and describe similarities and differences between birds and planes; to understand people mimicking birds flying.

Materials: Pictures of airplanes and birds in flight.

Skills: Comparing and observing.

Time: 30 minutes.

Instructional Methods:

- 1) Compare pictures of birds and planes in flight. Notice the similarities and differences between birds' and planes' systems. EX: They both have bodies, flat tails, wings, and "feet." (See next page)
- 2) Read the story/legend of Icarus who made wings of wax. Talk about men trying to fly like birds.
- 3) Show a movie of early aircraft by inventors that failed, or show the movie Goofy's Glider (appendix).

An airplane is something like a bird—

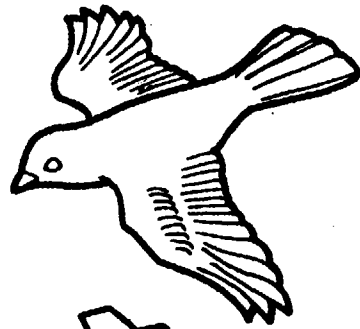

It has a body;



and a flat tail;

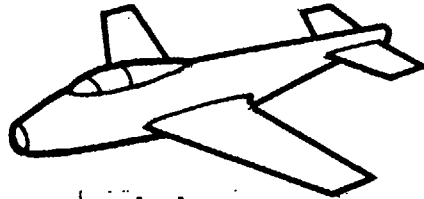

and wings;

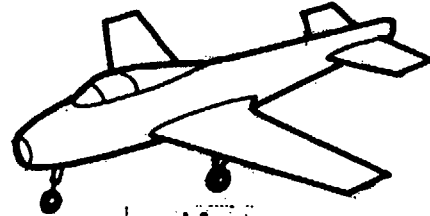

and feet.

GROUP 1 - 42

FUN WITH PLANES

Objectives: To discover that changing configurations affect the flight of an airplane.

Materials: Sheets of 8 1/2'' x 11'' paper (scrap paper can be used), 5 buckets, 5 small flags, graph paper, pencil, clipboard.

Skills: Observing, describing, measuring, manipulating variables

Time: 60-90 minutes

Instructional Methods:

- 1) Create paper planes.
Number buckets from 1-5. Place them 5 feet apart. Children will fold paper planes and starting at a designated distance from the first bucket, launch the plane toward the bucket. Each child is given two chances per bucket. The object of the game is to get the plane inside the bucket on the first try.
- 2) Explain that we will be observing what happens as planes are sailed toward the target. Adapt the above procedures to accommodate the entire class.

EXAMPLES:

- Divide the class into two teams and proceed with the above activity.
- One group may record the results on a graph while the other plays.
- Place some "hazards" on the course, such as one flag per bucket, greater distance between buckets, one chance per bucket, etc.

NAME THAT PART

Objectives: To name the various parts of the airplane, and give operational definitions.

Materials: Worksheets (following two pages), crayons, glue, cardboard, scissors, assembled plane to use as a model.

Skills: Observing

Time: 3 separate lessons

Instructional Methods:

- 1) Go to a small airport. Look at the real airplanes. Have students point out the parts of the airplane.
- 2) Bring in or have the students make model airplanes. Have the students point out the parts of the airplanes.
- 3) Distribute the two worksheets. Discuss definitions and the location of the various parts. Extend the activity by having the children color specific parts. **WORK SLOWLY TO AVOID CONFUSION.**
- 4) Cut and paste pieces on cardboard. Arrange and assemble their own planes. Display as mobiles.
- 5) Discuss the concept of a system. Note that an airplane is a system composed of sub systems, such as wings, tail, fuselage, landing gear, etc. Sub-systems in turn have their own sub-systems such as the tail, which is made up of a rudder, horizontal stabilizer and the elevator.
- 6) Students create their own plane by changing wing configuration or elongating the fuselage, etc. Remembering the basic parts are crucial!

PARTS OF AN AIRPLANE

FUSELAGE	Central body portion of airplane. Designed to carry the crew, passengers or cargo.
COCKPIT	The space in the fuselage for the pilot and in a small plane for passengers.
CABIN	The space in the fuselage of a larger plane for passengers.
PROPELLER	A rotating blade on the front of the plane. The engine turns the propeller. The propeller most often pulls the plane through the air.
WINGS	The parts of the plane which provide lift and support the weight of the plane and its passengers, crew and cargo while the plane is in flight.
FLAPS	Movable sections of the plane's wings closest to the fuselage. They move to enable the plane to fly more slowly.
AILERONS	Movable sections of the plane's wings found on the outer part of the wing. They move in opposite directions (one up and one down) and are used to make turns. (bank)
RUDDER	The movable (vertical) section of the tail which controls lateral (side) movement. (Right & Left)
HORIZONTAL STABILIZER	The horizontal stabilizer is the horizontal (level) surface of the rear part of the fuselage. It is used to balance the airplane.
ELEVATOR	The moveable horizontal section of the tail which allows the plane to move up and down.
LANDING GEAR	Located underneath the plane, it allows the plane to land and supports it while on the ground.

The Main Parts Of an Airplane

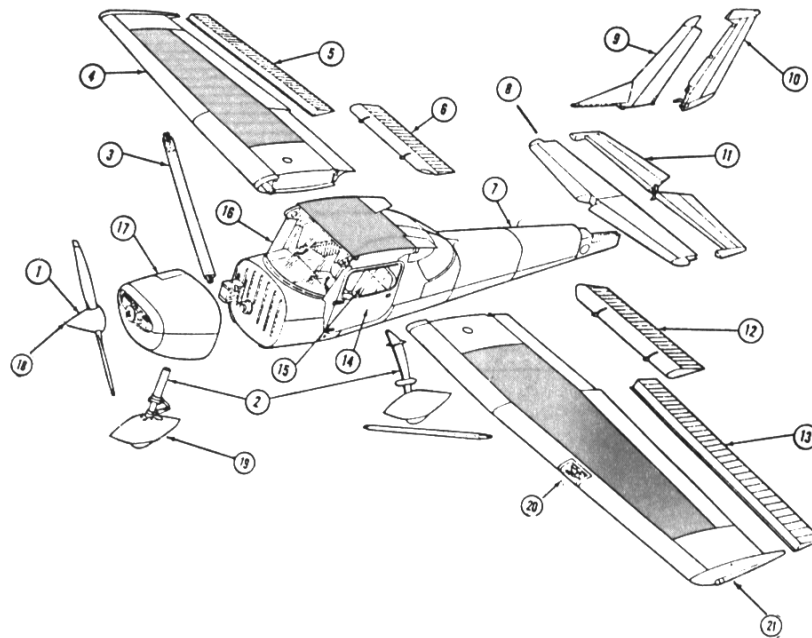

1. Propeller
2. Landing Gear
3. Wing Strut
4. Wing
5. Right Wing Aileron
6. Right Wing Flap
7. Fuselage
8. Horizontal Stabilizer
9. Fin and Dorsal
10. Rudder
11. Elevator

12. Left Wing Flap
13. Left Wing Aileron
14. Door
15. Seat
16. Windshield
17. Engine Cowl
18. Spinner
19. Wheel Cover
20. Landing Light
21. Wing Tip Light

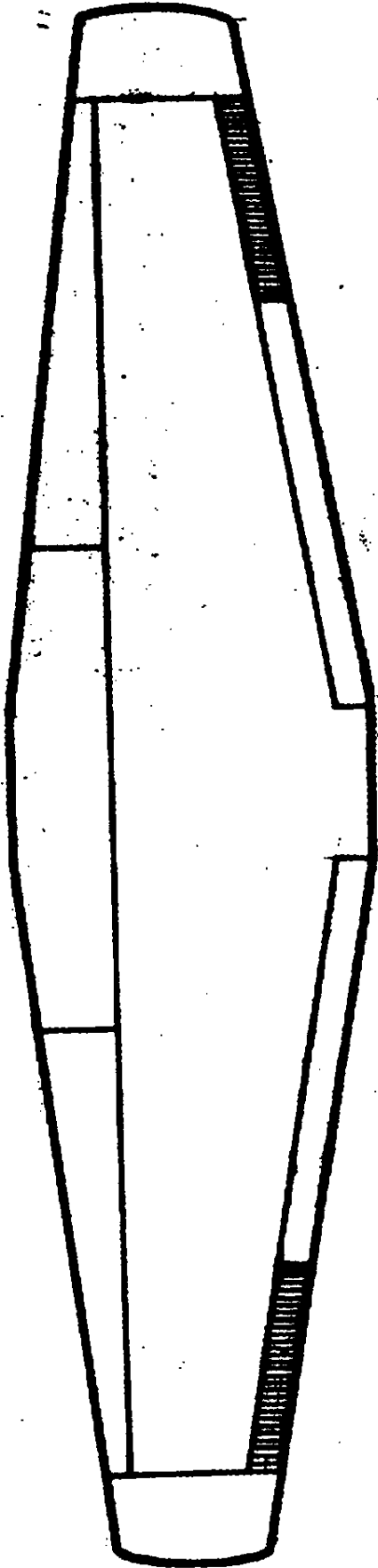
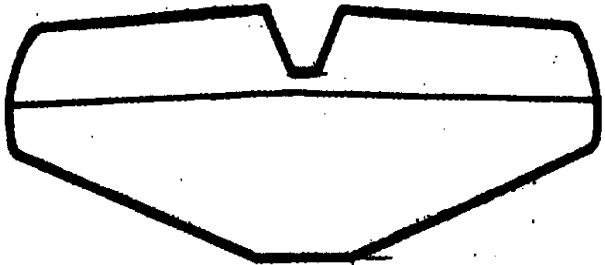
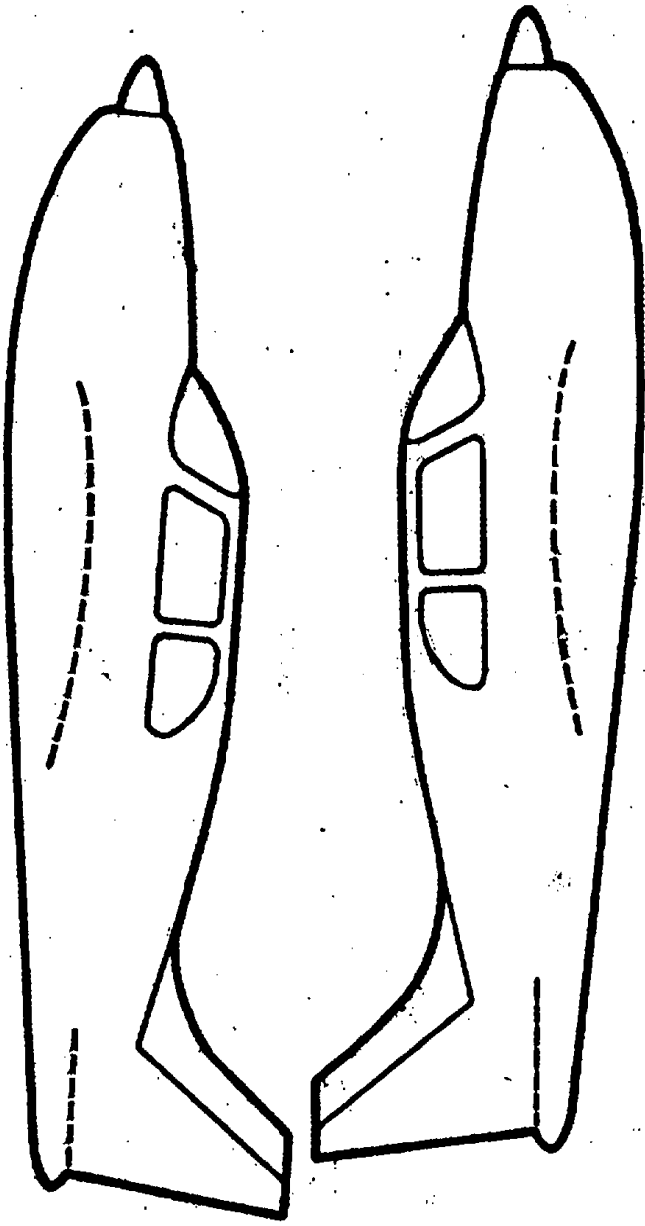

LABEL THOSE PARTS!!

Objectives: To label the main parts of an airplane.

Materials: Worksheet on the following page, construction paper, glue, scissors, 17 cards labeled with the main parts of a plane.

Skills: Following directions, listening, locating.

Time: 30 minutes

Instructional Methods:

- 1) Discuss the worksheet. Review the parts they know. Locate the word parts that are new.
- 2) Locate the parts on the diagram.
- 3) Cut an airplane out of a magazine or draw an airplane and label all the parts. Paste construction paper. Use worksheets as a guide.
- 4) Students will organize into small groups and take a label relative to the parts of the airplane; when the word rudder is flashed, student labeled rudder" will pronounce the word and say: "I help the airplane turn."

THE INCREDIBLE FLYING MACHINE

Objectives: To list the names and characteristics of different aircraft and spacecraft.

Materials: Worksheets, pencils, crayons

Skills: Describing, comparing and matching

Time: 30 minutes

Instructional Methods:

- 1) Distribute worksheet (next page). Have the children describe characteristics of each aircraft, noting the similarities and differences.
- 2) Ask students if they have ever seen or ridden in any of these aircrafts. Describe their observations and/or experiences. Complete the worksheet.
- 3) Note that each object is made up of different parts. These basic parts put together make a system. (EX: A monoplane has 1 set of wings, body, wheels, propeller, etc.)
- 4) Distribute the worksheet and discuss each sentence. Match the pictures with the statements on the following page.

ON OUR OWN

Objectives: To observe that various airplane designs demonstrate different flight principles.

Materials: Scrap paper, paper clips (for balance), scotch tape, glue/stapler.

Skills: Constructing, testing, modifying

Time: 45 minutes

Instructional Methods:

- 1) Encourage the students to create their “own” airplanes. Ask the students to test their creation for accuracy, durationor aerobatics. Modify as necessary.
- 2) Accuracy: Winner must fly the farthest along a given length.
Duration: Winner must keep his/her plane in flight for a designated period of time.
Aerobatics: The winner must perform a designated maneuver prior to the airplane’s launch.
- 3) Discuss the observations of each maneuver. Where did the energy (motion) come from in the above categories?

CAN YOU FIT THE SHAPES?

Objectives: Review 3 basic shapes (triangle, circle, and rectangle/square). Create a rocket in space.

Materials: Scissors, paste, crayons, black paper, colored construction paper, aluminum foil, sandpaper, glitter, markers and tissue paper. Picture of an entire rocket and a rocket divided into 8 pieces (5 triangles, 1 rectangle, 1 square, and 1 circle insert). (See pages 4 and 5)

Skills: Observation, motor coordination, creation of an art project.

Time: Approximately 30 minutes

Instructional Methods:

- 1) Duplicate the worksheet. Discuss the various shapes, noting triangles, circles, and rectangles (square).
- 2) Have children cut out the rocket and paste on black paper to simulate rocket in space. Then add moon, stars, sun, etc. out of the variety of materials.
- 3) Have the children cut out the rocket pieces and see if they can assemble them into a rocket.

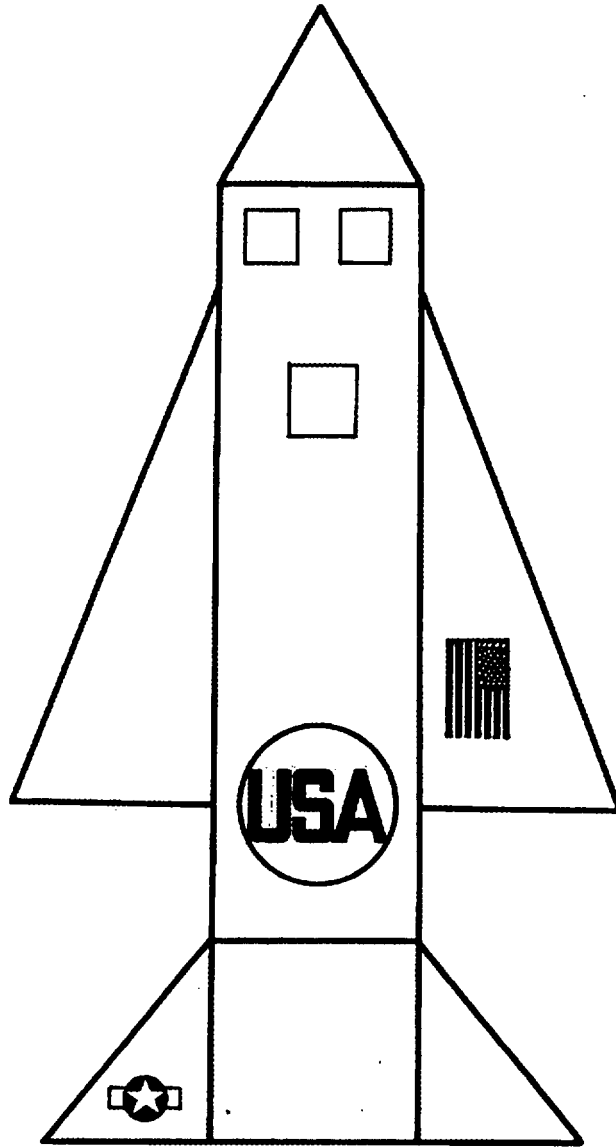

UNIT V

SPACE

Outer space is known as the final frontier. The environment in space is unsuited to human beings. To survive during space travel, a person must be supplied with an environment similar to earth. Oxygen must be supplied inside a spacecraft to insure human survival. Also, heat, cold, weightlessness, food, water, etc. are special problems.

Space travel requires speeds as high as 18,000 miles per hour and more. Such high speed, in itself, is harmless. (The rotation of the earth moves at a speed greater than 700 miles per hour. The earth also carries us around the sun at a speed of about 66,000 miles per hour. Also, the solar system revolves around the center of our galaxy at about 43,000 miles per hour.)

SPACE EXHIBIT

Objectives: To observe space exhibit at a museum. To draw pictures and write stories about the trip experience.

Materials: Field trip to a space exhibit at a museum.

Skills: Observing, developing and expanding vocabulary.

Time: A half day.

Instructional Methods:

- 1) Read stories about astronauts.
- 2) Visit the Museum and observe the space exhibit.
- 3) Follow-up by drawing pictures and dictating or writing stories about space.

SPACE LEARNING CENTER

Objectives: To role play astronauts traveling in a spaceship.

**Materials/
Set-up:** Set up one corner of the room for a spaceship. Make a cardboard construction with dials for operating the spaceship. Supply helmets and boots for the astronauts to wear as dress ups. Make play food for the astronauts. (obtain astronaut freeze dried food.)

Skills: Increasing vocabulary related to astronauts in space.

Time: Free choice period for the duration of the unit.

Instructional Methods:

- 1) After setting up the learning center, allow 3 to 4 students to select the center during free choice period. Have the center available for the duration of the unit.
- 2) Follow-up by having the students draw pictures and tell/write stories about space.

ROCKETS

Objectives: To discover that jets and rockets get their thrust from air molecules; to identify the combustion chamber as one part of an engine involved with thrust.

Materials: Balloon, empty bottle, pan of water, hot plate.

Skills: Observing

Time: 20 minutes

Instructional Methods:

Place a pan of water on the hot plate. Inside, place an empty bottle secured with a balloon. Convey the idea that the air molecules in the bottle will move vigorously and bounce farther apart. The air expands, pushing against the bottle. What's likely to happen? Why?

SPACE COLONY

Objectives: To cooperate in groups. To design a model space colony.

Materials: Wood, cardboard, clay or play dough, construction paper, boxes, scissors, paint, markers, foil, glitter, etc.

Skills: Designing, researching

Time: 4 periods of 60 minutes

Instructional Methods:

- 1) Divide students into groups. Have them research how people could live in space and then design and build their own space colony.
- 2) Have a space exhibit of all the different space colonies.

SUPPLEMENTARY ACTIVITIES

Directions: Put addition/subtraction problems on wings, fuselage, tail, propeller, etc.
Students color plane parts. Students solve the parts as listed.

Color code:

- 10 - Red
- 8 - Blue
- 6 - Yellow
- 4 - Black
- 2 - Green
- 5 - Purple

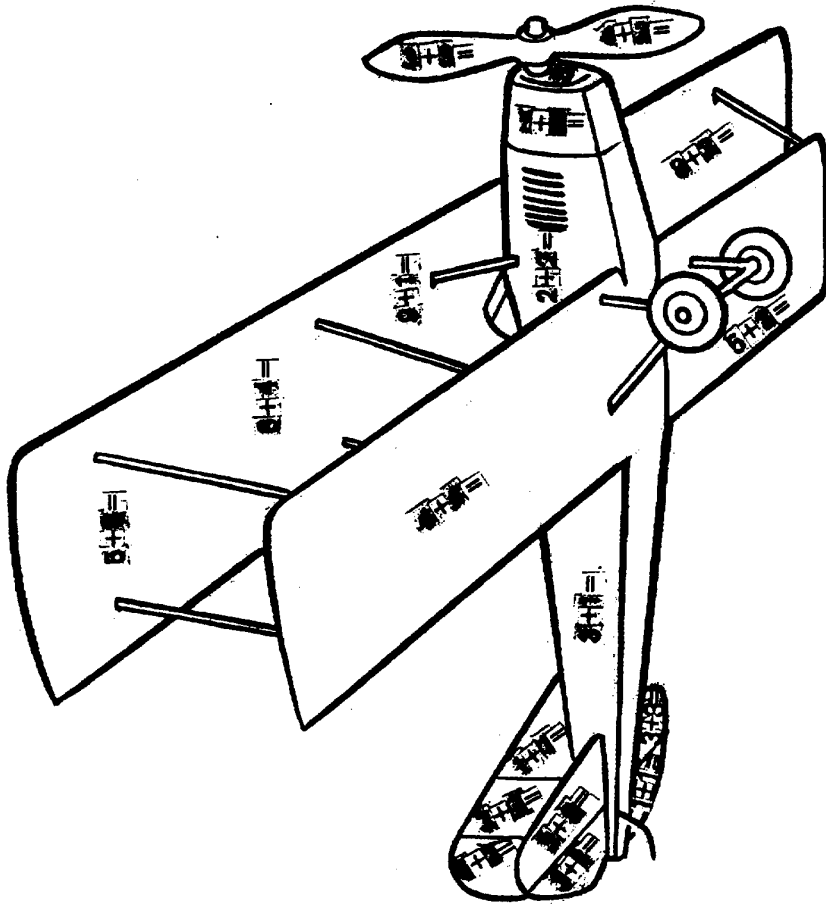

AIRCRAFT AND SPACECRAFT

A **Monoplane** is a plane - with one big wing.

Balloons are filled with hot air, which makes them go up.

A **helicopter** has a wing that rotates.

A **biplane** is a plane with two pair of wings.

A **rocket** goes off far into space.

The space **shuttle** carries people into space and brings them home again.

AIRCRAFT AND SPACECRAFT

Copy the word from the list that matches the drawing. Cut out drawing and match them with the description on the next page. Color the drawings and paste in place.

helicopter

monoplane

shuttle

biplane

rocket

balloon

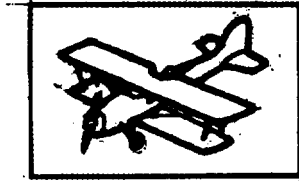

b _____



r _____



m _____

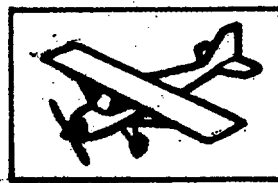

s _____

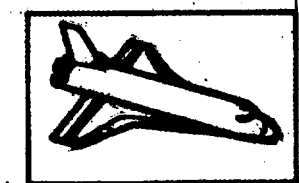

h _____

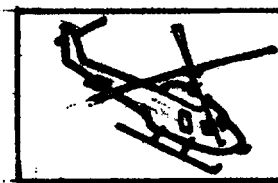

b _____

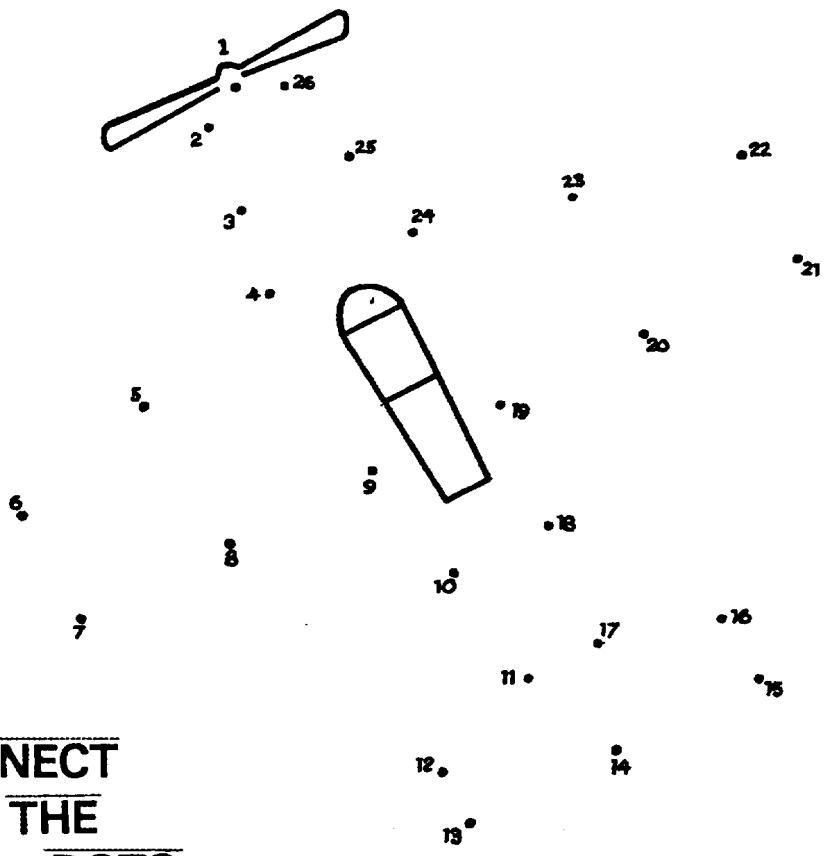

CONNECT
THE
DOTS

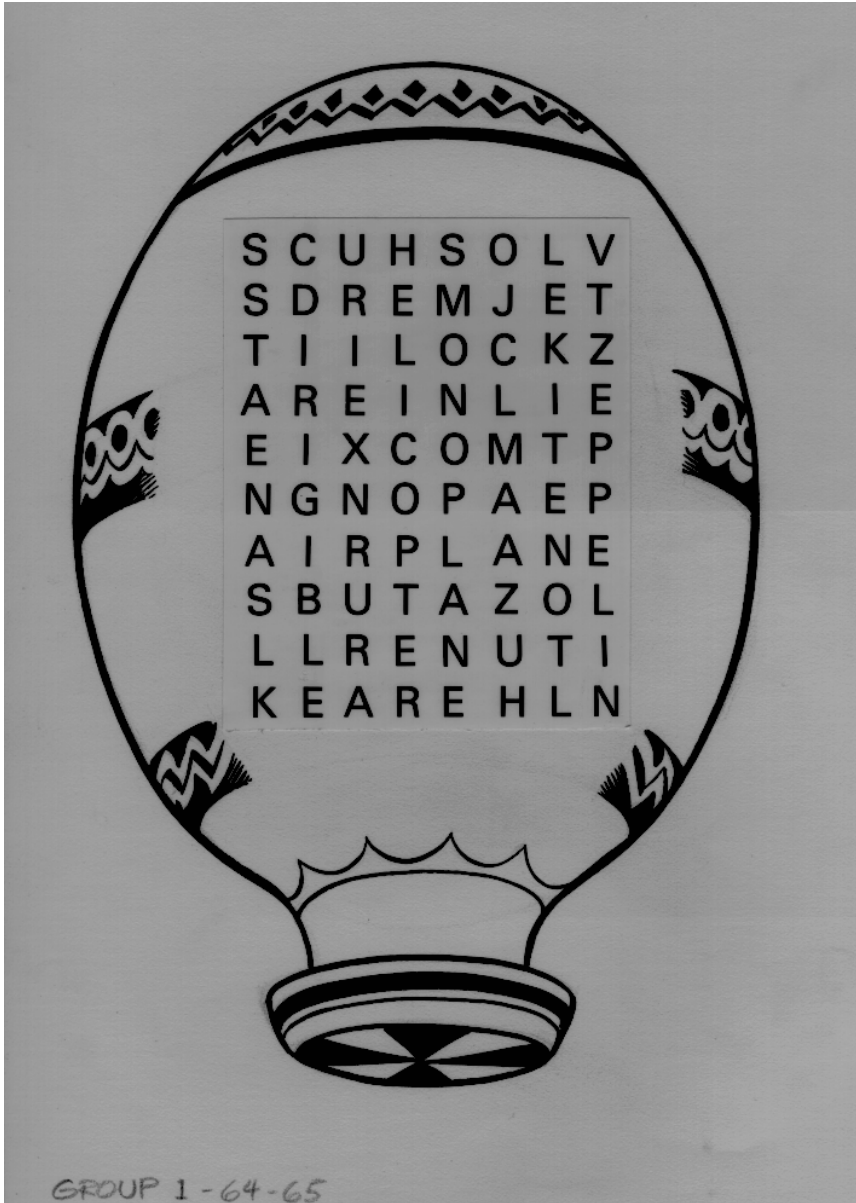

Searching
for:

monoplane
jet
kite
SST
airplane
helicopter
dirigible
zeppelin

Key

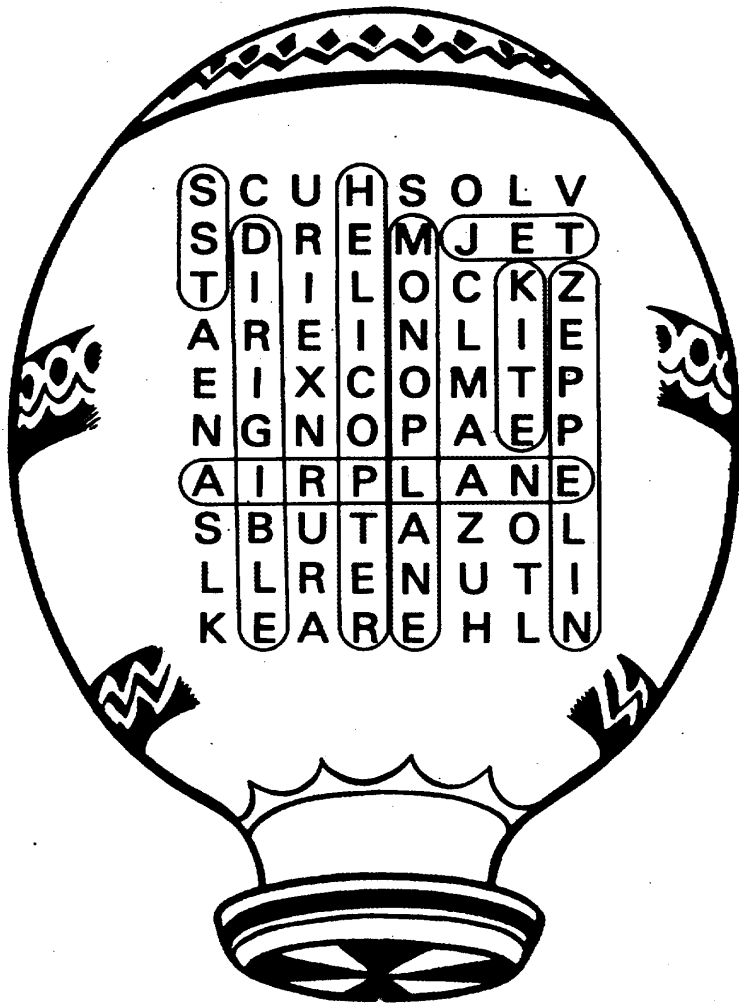

Searching
for:

- monoplane
- jet
- kite
- SST
- airplane
- helicopter
- dirigible
- zeppelin

SPELLBOUND

Add or subtract the letters to name the parts of an airplane.

1. west - est + ing
2. den - d + gift - ft + nest - st
3. rub - b + dog - og + desk - sk + ray - ay
4. Cook - ok + pick - pi + pit
5. property - erty + elm - m + l + er
6. aim - m + less - ss + romp - mp + n
7. fit - it + lag - ag + are - re + pen - en
8. tame - me + ill - l

**SPELL BOUND
KEY**

Add or subtract the letters to name the parts of an airplane

1. west - est + ing

wing

2. den - d + gift - ft + nest - st

engine

3. rub - b + dog - og + desk - sk + ray - ay

rudder

4. cook - ok + pick - pi + pit

cockpit

5. property - erty + elm - m + l + er

propeller

6. aim - m + less - ss romp - mp + n

aileron

7. fit - it + lag - ag + are - re + pen - en

flap

8. tame - me + ill - l

tail

Unscramble the following words to name people and places found in an airport.

wjtaye

tilpo

cnamheci

xytwaia

segpasrnes

mapr tagne

metrnail

naghra

(cut here)

KEY

Unscramble the following words to name people and places found in an airport.

wjatye

jetway

tilpo

pilot

cnamheci

mechanic

xytwaia

taxiway

segpasrnes

passengers

mapr tagne

ramp agent

metrnail

terminal

naghra

hangar

AIRPORT COMPUTATION

- 1) If a round trip ticket from Houston to Chicago costs \$283.00 for an adult and \$112.00 per child, how much would it cost for two adults and two children to fly?
- 2) A plane left Tulsa with 98 passengers on board. At Kansas City, 42 boarded. How many passengers are on the plane now?
- 3) Sue's plane left St. Louis at 10:10 a.m. local time. She arrived in Sacramento at 2:34 p.m. local time. How long was Sue in the air?
- 4) A class is taking a tour of the city by airplane. The teacher's ticket will cost \$12.00. Each student will have to pay \$4.00. How much will it cost a class of 10 students and 1 teacher?
- 5) A plane's crew consists of ten people. If there are three flight attendants in first class, a pilot, co-pilot, and a flight engineer, how many flight attendants are in second class?

(cut here)

AIRPORT COMPUTATION KEY

- 1) If a round trip ticket from Houston to Chicago costs \$283.00 for an adult and \$112.00 per child, how much would it cost for two adults and two children to fly?

(\$566.00 + \$224.00 = \$790.00)
- 2) A plane left Tulsa with 98 passengers on board. At Kansas City, 42 boarded. How many passengers are on the plane now?

(98 + 42 = 140)
- 3) Sue's plane left St. Louis at 10:10 a.m. local time. She arrived in Sacramento at 2:34 p.m. local time. How long was Sue in the air?

(6 hours 24 minutes)
- 4) A class is taking a tour of the city by airplane. The teacher's ticket will cost \$12.00. Each student - will have to pay \$4.00. How much will it cost a class of 10 students and 1 teacher?

(\$40.00 + \$12.00 = \$52.00)
- 5) A plane's crew consists of ten people. If there are three flight attendants in first class, a pilot, co-pilot, and a flight engineer, how many flight attendants are in second class?

(4)

COUNT THOSE SYLLABLES

_____ altimeter

_____ windshield

_____ propeller

_____ fuselage

_____ baggage

_____ navigator

_____ ailerons

_____ altitude

_____ stabilizer

_____ radar

_____ helicopter

_____ airport

_____ biplane

_____ mechanic

_____ pilot

_____ cargo

_____ flight

_____ engine

APPENDIX

AUDIOVISUAL MATERIALS

BONANZA WEST

Film (16 mm) A/V E.S.
Film depicts a trip to numerous national and state parks in the western part of the U.S. It is interesting from an aviation viewpoint and is, because of the scenery, enjoyable entertainment for the non-pilot. 20 min. Color.
Illinois Division of Aeronautics
One Langhorne Bond Drive
Springfield, IL 62706
217 753-4400

WINGS FOR ROGER WINDSOCK

Film (16mm) A/V E.S.
An animated story of a boy who dreams of piloting early airplanes and of the exciting adventures of an airplane pilot. A good film to stimulate the interest of youth in aviation. Also shows various aviation careers. #SD-16-6051. 15 min. B&W. Rental fee.
Soaring Society of America, Inc.
Film Library
JR.D. #1, Harris Hill
Elmira, NY 14903
607 734-3128

GOOFY'S GLIDER

Film (16 mm) A/V E.S.
A Walt Disney cartoon showing that well-known canine character involved in the problems surrounding the "do-it-yourself" method of learning to fly a glider. A Walt Disney Production. #SD-16-7052. 8 min. Color.
Rental fee.
Soaring Society of America, Inc.
Film Library
R.D. #1, Harris Hill
Elmira, NY 14903
607 734-3128

HOW AIRPLANES FLY

Film (16mm) A/V E.S.
What makes an airplane get off the ground and stay in the air? Easy to understand film combines animation and live sequences to explain basic aerodynamics. Forces of lift, weight, thrust and drag are shown in relation to flight. 18 min. Color. FAA Film. #11131
Modern Talking Picture Service, Inc.
FAA Film Series
5000 Park Street, N.
St. Petersburg, FL 33709

CAREER INFORMATION

CAREERS IN AVIATION/AEROSPACE

Booklet CI E.S.

The booklet contains an outline for a field trip to an airport. The 4-hour program is divided into two sections consisting of : one hour of lecture and discussion, and 3-hour visit to all the different parts of the airport.

Excellent for obtaining ideas.

Maryland State Aviation Administration
P.O. Box 8766
BWI Airport, MD 21240
301 859-7111

LOOKING UP TO YOUR AVIATION CAREER

Film (16mm) C.I.E.S.

Film illustrates how careers in aviation present wide-ranging opportunities for achievement, challenge and responsibility in over 60 different specialties. Features aviation professionals supporting air operations on the ground. 14 min. Color.

#11314

FAA Film

Modern Talking Picture Service, Inc.

FAA Film Series

5000 Park Street, N.

St. Petersburg, FL 33709

813 541-7571

PUBLICATIONS

A TRIP TO THE AIRPORT - UN VIAJE AL AEROPUERTO

Pamphlet PUB E
Pamphlet contains English-Spanish bilingual materials. Bilingual text with clear illustration, list of activities, bilingual glossary of aviation words, directions on how to build a paper airplane, connect-the-dots picture, diagram of parts of an airplane, and a picture of an instrument panel. 39 pages. GA-300-120
FAA Educational Materials
Superintendent of Documents
8610 Cherry Lane
Laurel, MD 20707

AUGUST MARTIN ACTIVITIES BOOK

Booklet PUB E
This book is designed for use at the elementary education level. The learning activities are based on the biography of the world's first black airline pilot.
GA-300-143A
FAA Educational Materials
Superintendent of Documents
8610 Cherry Lane
Laurel, MD 20707

AVIATION SCIENCE ACTIVITIES FOR ELEMENTARY GRADES

Pamphlet PUB E
This pamphlet contains science demonstrations pertaining to the physical properties of air. Experiments listed are designed to be used with simple equipment. Single copies are free.
GA-20-30
FAA Educational Materials
Superintendent of Documents
8610 Cherry Lane
Laurel, MD 20707

CLOUD CHART

Chart PUB E.S.
A full color chart (20" x 25") describes the kind of weather associated with various cloud formations. The chart has an average cloud altitude scale, major classifications of cloud types and altitudes at which they occur. #AA#78009-22. Purchase only.
Cessna Aircraft Co.
Air Age Education Department
P.O. Box 1521
Wichita, KS 67201
316 685-9111

CLOUD RECOGNITION

Chart PUB E.S.
Provides illustrations and descriptions of cloud types including atmospheric position, formation criteria and weather usually associated with these clouds.
Virginia Department of Aviation
Operations Specialist
4508 S. Laburnum Avenue
POB 7716
Richmond, VA 23231
804 786-3685

COLORING BOOKS

Book PUB E

The following is a list of interesting coloring book titles: All Kinds of Planes, Antique Aeroplanes, The Challenge of Flight, 4-in-1 Aerospace, Some Aviation Workers. For more information, please contact the IDOT source noted below for details.

IDOT - Division of Aeronautics
Av. Education Coordinator
310 S. Michigan Avenue, Suite 2240
Chicago, IL 60504
312 793-2436

COME FLY WITH ME, K-6 TEACHER'S MANUAL

Book PUB E

Manual acts as an innovative aid for teaching weather, energy, and theory of flight and space. Written by teachers for teachers, each includes objectives, teaching strategies, procedures, and lists of materials needed which apply to the concepts to be learned. For Purchase Only
Michigan Aeronautics Commission
Capital City Airport
Lansing, MI 48906
517 373-3871

THE COMMUNITY AND ITS AIRPORT

Kit PUB E

This kit is designed to be used with elementary school age students to make them aware of what may be going on at the airport and its importance to the community.

IDOT - Division of Aeronautics
Aviation Education Coordinator
310 S. Michigan Avenue, Suite 2240
Chicago, IL 60604
312 793-2436

PICTURES OF AIRCRAFT: AIRPLANES

Lithographs PUB E.S.

Information packet contains 5" x 9" lithographs (color and B&W) of the most popular Boeing airplane products (B727, B747). Each lithograph has a description and technical information about the airplane. Excellent for use during aviation units. A brief history is included. Plan a minimum two week delivery period.

The Boeing Commercial Airplane Co.
Public Affairs Office
P.O. Box 3707
Seattle, WA 98124
206 237-1710

PICTURES OF AIRCRAFT: HELICOPTERS

Lithographs PUB E.S.

The 8" x 10", B&W lithographs are of the helicopter products made by Bell Helicopter Textron Inc. (Jetranger, Longranger, etc.) They are excellent for bulletin board displays during aviation units. Quantities are limited. Planning should include a possible six week delivery period.

Bell Helicopter Textron Inc.
Public Relations Department
P.O. Box 482
Forth Worth, TX 76101
817 280-2011

BIBLIOGRAPHY

_____, Aerospace Education Defined, a programmed learning exercise, Civil Air Patrol National Headquarters, Maxwell Air Force Base, Alabama, 36112-5572, 1986.

_____, Airway Science Curriculum Proposal - Proposal Information and Instructions, Section One (Advance Copy), Federal Aviation Administration, Washington, D.C., January, 1993.

Bacon, Harold R., Schrier, Michael D., McGill, Patricia F., Hellinga, Gerald D., Aerospace: The Challenge, (Third Edition), Civil Air Patrol National Headquarters, Maxwell Air Force Base, Alabama, 1989.

Bergstrom, Dr. Scott J., Distance Education for the Airway Sciences: Promises and Challenges Report Delivered at Dowling College Transportation Forum, January 7, 1993.

Blank, Rolf K., Dentler, Robert A., Baltzell, D. Catherine, Chabotar, Kent, Survey of Magnet Schools - Analyzing A Model for Quality Integrated Education, Prepared by James H. Lowry and Associates, Abt Associates, Inc., Subcontractor, Final Report of a National Study for U.S. Department of Education, Office of Planning, Budget and Evaluation, Contract No. 300-81-0420, September, 1983

Bondurant, Jr., Dr. R. Lynn, Olson, Curt, Peterson, Pamela K. Sauk Rapids High School - Secondary Aerospace and Applied Technology Business - Education Partnership, Sauk Rapids, Minnesota, Second Draft, 1991.

Busey, Admiral James B., FAA Administrator, Aviation Education Policy Statement, Washington, D.C., 1991.

Busey, Admiral James B., FAA Administrator, Remarks Before Aerospace Education Center, Little Rock, Arkansas, April 12, 1991.

Conway, Lee, "Classroom in the Sky: A Power Trip for Disadvantaged Youth," Phi Delta Kappan, May, 1976.

Aviation Education

P.O. Box 8766

BWI Airport, MD 21240

301 859-7111

Crain, Robert L., Heebner, Amy L., Si, Yiu-Pong assisted by Jordan, Will J., Kiefer, David R., Teachers College, Columbia University, The Effectiveness of New York City's Career Magnet Schools: An Evaluation of Ninth Grade Performance Using An Experimental Design, National Center for Research in Vocational Education, University of California at Berkeley, 1995 University Avenue, Suite 375, Berkeley, California 94704, Study Supported by the Office of Vocational and Adult Education, U.S. Department of Education, April, 1992.

BIBLIOGRAPHY (Cont'd)

Estes, Nolan, Levine, Daniel U, Waldrip, Donald R., Magnet Schools Recent Developments and Perspectives Morgan Printing & Publishing, Inc., 900 Old Koenig Lane, Suite 135, Austin, Texas 78756, 1990.

_____, Federal Register/Volume 48, No. 137/Friday, July 15, 1983/Notices, Office of Personnel Management Demonstration Project: Airway Science Curriculum

Goldberg, Isadore, Randall Aerospace and Marine Science Project (RAMS) An Evaluation Study An Aviation Education Publication, U.S. Department of Transportation, Federal Aviation Administration, Washington, D.C., September, 1977

Helmick, Edward F. and David, Lewis, Mastering Flying Basics in the Simulator Or How to Reduce the Cost of the Private Pilot Certificate, Frasca International, Inc., 906 East Airport Road, Urbana, Illinois, 61801, November 18, 1991.

Pentti, Frank W., Deputy Director, Office of Intermodal Transportation, U.S. Department of Transportation, Address to New York Chapter, Transportation Research Board, November 5, 1992.

Powell, Margaret L., Manager, Airway Science Curriculum Project, Information Paper: Airway (AWS) Curriculum Program Federal Aviation Administration, Office of Training and Higher Education, 400 7th Street, SW, PL-100, Washington, D.C. 20590, February, 1993.

Preston, Edmund, Agency Historian, Federal Aviation Administration, Information Provided from the Draft Revision to the FAA Historical Fact Book in letter to Dr. Mervin K. Strickler, January 19, 1993.

_____, Public Law 100-297 - April 28, 1988, Title III - Magnet Schools Assistance 20 USC 3023.

Racosky, Major Richard J. "Rico" (ANG), dreams + action = Reality Programs 1992, Actiongraphics Publishing, International, P.O. Box 186, Mount Clemens, Michigan 48046-0186.

Rivera, Fanny, Remarks, at Second Annual Aviation Magnet School Conference, Phoenix, Arizona, November 20, 1992.

Simpson, Dr. Ronald P., Letter to Dr. Mervin K. Strickler, Jr., March 23, 1993, reporting that the first phase of the National Magnet School Survey is completed, Kansas City, Missouri. Report to be published by Magnet Schools of America, College of Education, University of Houston, 401 Farish Hall, Houston, TX

Smith, Maxine, Information Packet on Castlemont Aviation High School Program Oakland, California, November 1992.

BIBLIOGRAPHY (Cont'd)

Strickland, Patricia, The Putt-Putt Air Force - The Story of the Civilian Pilot Training Program and the War Training Service - 1939-1944, published by Aviation Education Staff, U.S. Department of Transportation, Federal Aviation Administration, Washington, D.C., 1970.

Strickler, Jr., Mervin K., Background Paper for First National Leadership Institute on Aerospace Education Magnet Schools, Aerospace Magnet Schools - Past - Present - Future, Little Rock, Arkansas, November 21, 1991.

Strickler, Jr., Mervin K., (Editor), An Introduction to Aerospace Education New Horizons Publishers, Inc., Chicago, 1968. Chapter 2: The Scope of Aerospace, Raymond J. Johnson and Jean F. Blashfield. Aerospace Education History Material is Adapted From Chapter 19: History of Aerospace Education, by Mervin K. Strickler, Jr.

Strickler, Jr., Mervin K., and Dobson, Charles L., Learning Through Aviation Prepared for Publication for the George R. Wallace Research Center, Embry - Riddle Aeronautical University, Daytona Beach, Florida and also published by: Office of General Aviation, Federal Aviation Administration, May, 1978.

Studebaker, John W., and Hinckley, Robert H., Air-Conditioning Young America published by Civil Aeronautics Administration (CAA), U.S. Department of Commerce and U.S. Office of Education, Federal Security Agency, May, 1942.

_____, U.S. Department of Transportation (DOT), Federal Aviation Administration (FAA), Office of Public Affairs Aviation Education Program, A Model Aerospace Aviation Curriculum Based on August Martin High School Manuscript By: Dr. Mervin K. Strickler, Jr., Washington, D.C. (Developed for FAA in Conjunction with the Center For Aerospace Education Development, Civil Air Patrol Headquarters, Maxwell Air Force Base, Alabama, Originally Published 1980, Reprinted by FAA, 1991.

_____, U.S. Department of Education, Office for Civil Rights, Washington, D.C. 20202-1100, Magnet Schools: Promoting Equal Opportunity and Quality Education, May, 1991.

Aviation Education Resource Centers

Alabama

Alabama Aviation
Technical College
Ms. Megan Johnson, Director
Learning Resource Center
PO Box 1209
Ozark, AL 36361
(205) 774-5113

University of North Alabama
Ms. Michele R. Walker
Programming Coordinator
UNA Box 5145
Florence, AL 35632-0001
(205) 760-4623

University of Aviation Association
Ms. Carolyn Williamson
3410 Skyway Drive
Auburn, AL 36830
(205) 844-2434

Alaska

University of Alaska Fairbanks
Ms. Dennis Stephens
Collection Development Officer
Elmer E. Rasmuson Library
Fairbanks, AK 99775-1006
(907) 546-8207

Alaska Pacific University
Dr. Rusty Myers, Project Director
4101 University
Anchorage, AK 99508
(907) 564-8207

University of Alaska Anchorage
Ms. Barbara Sokolov
Library Director
3211 Providence Drive
Anchorage, AK 99508
(907) 786-1825

Arizona

Embry-Riddle Aeronautical Univ.
Ms. Karen Hudson
Educational Program Coordinator
3200 N. Willow Creek Road
Prescott, AZ 86301
(602) 771-6673

South Mountain High School
Mr. Ron Dalton
Center for Aerospace Education
5401 S. 7th Street
Phoenix, AZ 85040
(602) 877-8340

Pima Community College
Mr. Tony Gulielmino
Aviation Department Chair
1668 South Research Loop Road
Tucson, AZ 85730
(602) 884-6186

Flandrau Science Center
Mr. Gilbert McLaughlin
University of Arizona
Tucson, AZ 85721
(520) 621-4515

Arkansas

Crowley's Ridge Education Service
Coop.
Mr. Louis Midkiff
P.O. Box 377
Harrisburg, AR 72432
(501) 578-5426

Aerospace Education Center
Mr. Charlie Cook
3301 East Roosevelt Road
Little Rock, AR 72206
(501) 371-0331

California

Apple Valley Science & Tech. Cntr.
Mr. Rick Piercy, Coordinator
P.O. Box 2968, 15552 Wichita
Apple Valley, CA 95192-0081
(408) 924-6580

Museum of Flying
Mr. Harvey Ferer
2772 Donald Douglas Loop N.
Santa Monica, CA 90405
(310) 392-8822

San Bernardino Co. Super. of Sch
Ms. Nancy Harlan, Coordinator
Instructional Services Division
601 North E. Street
San Bernardino, CA 92410-3093
(714) 387-3152

Riverside County Office of Ed.
Ms. Janiel K. Esmeralda
Educational Resource Center - ERC
46-336 Oasis Street
Indio, CA 92201
(619) 342-3518

Fresno Unified School District
Instructional Media Center
Karen Tozllan
3132 E. Fairmont
Fresno, CA 93725
(209) 441-3672

Colorado

U.S. Space Foundation
Dr. Jerry Brown
Educational Director
2860 S. Circle Drive, Suite 2301
Colorado Springs, CO 80906-4184
(719) 576-8000

Metropolitan State
College of Denver
Mr. Jonathan R. Burke
Assistant Professor
Aerospace Science Department
Campus Box 30
P.O. Box 173362
Denver, CO 80217-3362
(303) 556-2923

Connecticut

Connecticut DOT
Bureau of Aviation and Ports
Mr. Robert Stepanek
Education Director
New England Air Museum
Bradley International Airport
Windsor, CT 06096

Platt/Sikorsky School for Aviation
Vivian Manzione, Assist. Director
Great Meadow Road
Stratford, CT 06497
(203) 381-9250

Delaware

Delaware Aerospace Center
Ms. Stephanie Wright
500 C. Duncan Road
Wilmington, DE 19809
(302) 761-7497

Florida

Embry-Riddle Aeronautical Univ.
Ms. Patricia Fleener-Ryan
AvEd Teacher Resource Center
Daytona Beach, FL 32114
(904) 226-6499

Florida Institute of Technology
Dr. Ballard M. Barker, Head
Department of Aviation Studies
The School of Aeronautics
150 West University Boulevard
Melbourne, FL 32901-6988
(407) 768-8000 ext. 8120

Florida Memorial College
Mr. J. Anthony Sharp, Director
Division of Airway Science
15800 Northwest, 42 Avenue
Miami, FL 33054
(305) 623-1440

Center for Mgmt. Development
Mr. Larry Hedman, CMD-240
4500 Palm Coast Parkway, SE
Palm Coast, FL 32137
(904) 446-7126

Georgia

Conyers Middle School
Ms. Viki Dennard
Assistant Principal
335 Sigman Road
Conyers, GA 30207-3699
(404) 483-3371

Museum of Aviation at Robins AFB
Ms. Joyce Carolton
Director of Education
P.O. Box 2469
Warner Robins, GA 31099
(912) 926-4242

East Cobb Middle School
Mr. Charles "Chuck" Nyren
380 Holt Road
Marietta, GA 30068
(404) 971-8397

Southern College of Technology
Georgia Youth Science &
Technology Center
Mr. Anthony Docal, Director
1100 S. Marietta Parkway
Marietta, GA 30060-2896
(404) 528-6272

Hawaii

Mid-Pacific Institute
Ms. Veronica Balsa, Director
Aviation/Space Resource Center
2445 Kaala Street
Honolulu, HI 96822-2204
(808) 973-5000

State of Hawaii
Department of Transportation
Mr. Rodney M. Kuba
Airports Division
Honolulu International Airport
Gate 29, EWA Service Court Road
Honolulu, HI 96819-1898
(808) 836-6542

Idaho

Idaho State Bureau of Aeronautics
Mr. John Maakestad
Safety/Information Officer
Chief Pilot
3483 Rickenbacker Street
Boise, ID 83705-5018
(208) 334-8775

Illinois

Parks College of St. Louis Univ.
Mr. Paul McLaughlin
Associate Vice Pres. and Dean
500 Falling Springs Road
Cahokia, IL 62206
(618) 337-7575 ext. 364

Southern Illinois University
Dr. Elaine Vitello
College of Technical Careers
Room 222
Carbondale, IL 62901
(618) 453-8821

State of Illinois
Division of Aeronautics
Mr. Richard M. Ware
One Langhorne Bond Drive
Capital Airport
Springfield, IL 62707-8415
(217) 785-8516

Northeastern Illinois University
Ms. Christine Wedam Rosario
College of Education
Chicago Teachers' Center
770 North Halsted Street
Suite 420
Chicago, IL 60623-5972
(312) 733-7330

Indiana

Indiana College of Placement &
Assessment Center
Mr. Hassan Chaharland
ICPAC Hotline Director
2805 E. 10th Street
Bloomington, IN 47408
(812) 855-8475

Iowa

The University of Northern Iowa
Ms. Julie Wilkinson
IRTS
222 Schindler Education Center
Cedar Falls, IA 50614-0610
(319) 273-2717

Kansas

Hutchinson Community College
Mr. Edward E. Berger, President
1300 N. Plum
Hutchinson, KS 67501
(316) 665-3505

Kansas State University-Saline
Ms. Karlene Propst
Tullis Library
2408 Scanlan Avenue
Salina, KS 67401
(913) 825-0275

Cloud County Community College
Dr. Patricia Altwegg
Box 1002, 2221 Campus Drive
Condordia, KS 66901
(1-800) 729-5101

Kentucky

Shawnee Aviation High School
Mr. Michael Rowland
4018 W. Market Street
Louisville, KY 40212
(502) 473-8689

Louisiana

Louisiana State University
Dr. Marlon Abbas, Director
Transportation System Group
Louisiana Trans. Research Center
4101 Gourrier Avenue
Baton Rouge, LA 7008
(504) 767-9127

Northeast Louisiana University
Mr. Ernie Bruce
Room 103, Chemistry & Natural
Sciences Building
Monroe, LA 71209-0590
(318) 342-1784

Maine

Kennebec Valley Tech. College
 Ms. Sue Doner
 92 Western Avenue
 Fairfield, ME 04937-0020
 (207) 453-9762

Biddeford School Department
 Ms. Sara Jane Poli
 Maplewood Avenue
 Biddeford, ME 04005
 (207) 282-8280

Penobscot Nation Tribal Admin.
 Mr. Mark Sanborn, Asst. Director
 Vocational Training & Education
 6 River Road, Community Bldg.
 Indian Island, ME 04468
 (207) 827-7776

Northern Maine Technical Center
 Mr. Timothy D. Crowley
 Dean of Students
 33 Edgemont Drive
 Presque Isle, ME 04769
 (207) 769-2461

Maryland

Univ. of Maryland Eastern Shore
 Mr. Abraham D. Spinak, Director
 Airway Science Program
 Tanner Hall
 30806 University Blvd., South
 Princess Anne, MD 21853-1299
 (410) 651-6489

Massachusetts

Bridgewater State College
 Mr. Bill Annesley
 Management Science & Aviation
 Science Department
 Bridgewater, MA 02325
 (508) 697-1395

North Shore Community College
 Dr. Robert Finklestein
 One Ferncroft Road
 Danvers, MA 01923
 (508) 762-4000 ext. 6296

Lexington Public School System
 Dr. Nicholas Tzimopoulos, Director
 Curriculum/Science Education
 1557 Massachusetts Avenue,
 Lexington, MA 02173
 (617) 861-2484

Westfield State College
 Mr. Stanley Derezinski
 1175 Granville Road
 Westfield, MA 01085
 (413) 569-8440

Massachusetts Aero Commission
 Dr. Toby Penstein
 Transportation Library
 10 Park Plaza
 Boston, MA 02116-3966
 (617) 973-8000

Michigan

Oakland University
 Ms. Karen Conrad, Interim Director
 Aviation & Space Center
 216 O'Dowd Hall
 Road 216
 Rochester, MI 48309-4401
 (313) 370-2485

Project STARS
 Ms. Barbara Koscak
 Box 450082, Building 814
 Selfridge ANG Base, MI 48045
 (313) 466-4884

Michigan Department of Trans.
 Bureau of Aeronautics
 Mr. Thomas Krashep, Manager
 2700 East Airport Service Drive
 Lansing, MI 48906
 (517) 335-9977

Minnesota

Minnesota DOT
 Office of Aeronautics
 Mr. Gordon Hoff, Director
 Aviation Education Relations
 222 East Plato Boulevard
 St. Paul, MN 55107-1618
 (612) 297-7652

Vermilion Community College
 Mr. Julius Salinas
 Aviation Director
 1900 E. Camp Street
 Ely, MN 55731
 (218) 365-7200

Mississippi

Jackson State University
 Dr. Harry A. Cooley, Director
 Airway Science Program
 1400 Lynch Street
 Jackson, MS 39217
 (601) 968-2471

Stringer Aerospace Ed. Center
 Mr. Mark Rice
 PO Box 68 Old Highway 15
 Stringer, MS 39481
 (601) 649-5566

Missouri

Lincoln University
 Mr. Al Myers, Director
 Career Advisement Planning &
 Placement Center
 127 Thyompkins
 Jefferson City, MO 65102-0029
 (314) 681-5477

Montana

Montana DOT Aeronautics Div.
 Mr. Michael D. Ferguson
 P.O. Box 5178
 Helena, MT 59601
 (406) 444-2506

Nebraska

University of Nebraska
 Dr. Brent Bowen, Director
 Aviation Institutes
 60th and Dodge
 Omaha, NE 68182-0508
 (402) 554-3424

Nebraska Dept. of Aeronautics
 Mr. Neil E. Vernon
 Aviation Specialist
 P.O. Box 82088
 Lincoln, NE 68501-2088
 (402) 471-2371

Nevada

Galena High School Comm. Library
 Frankie Lukaso
 3600 Butch Cassidy Way
 Reno, NV 89511
 (702) 851-5630

New Hampshire

New Hampshire DOT
Division of Aeronautics
Mr. Douglas W. Teel
65 Airport Road
Concord Municipal Airport
Concord, NH 03301-5298
(603) 271-2551

Daniel Webster College
Ms. Hanna McCarthy, President
20 University Drive
Nashua, NH 03063-1699
(603) 883-3556

New Jersey

Northeast Curriculum Coord. Center
Dr. Martha Poosi
Division of Vocational Education
Crest Way
Aberdeen, NJ 07747
(908) 290-1900

Atlantic Community College
Mr. Paul Rigby
5100 Black Horse Pike
Mays Landing, NJ 08330
(609) 343-5113

New Mexico

University of New Mexico
Mr. Richard S. Sanchez, Director
FAA/NASA Teacher Resource
Center
Division of Continuing Education
Albuquerque, NM 87131-4006
(505) 277-2631

New Mexico State University
Ms. Judy McShannon
Room 103, Goddard Hall
Las Cruces, NM 88003-0001
(505) 646-6414

New York

Dowling College
Dr. Albert E. Donor
Provost, Executive Vice President
Oakdale Long Island, NY 11769
(516) 244-3200

North Carolina

Elizabeth Aviation High School
Ms. Helen Caldwell
1704 Weeksville Road
Elizabeth City, NC 40212
(919) 334-3291

Wright Brothers National Memorial
Mr. Warren Wren
US 158 By-Pass
Kill Devil Hills, NC 27948
(919) 441-7430

North Dakota

Warwick Public Schools
Mr. Anthony Gagliardi
Warwick Career & Tech School
575 Centerville Road
Warwick, RI 02886
(401) 737-3300

Ohio

Bowling Green State University
Mr. Stephen M. Quilty, A.A.E.
Assistant Professor
Aerotechnology Program
Technology Annex
Bowling Green, OH 43403-0307
(419) 372-8926

Oklahoma

University of Oklahoma
Dr. Lee Morris, Director
Education & Aviation/Aerospace
1700 Asp Avenue
Norman, OK 73037-0001
(405) 325-1965

Oklahoma State University
FAA Resource Center
Mr. Steve Marks
308A CITD Building
Stillwater, OK 74078
(405) 744-7015

Oregon

Oregon Department of Trans.
Ms. Elizabeth Johnson
Aeronautics Division
3040 25th Street, S.E.
Salem, Oregon 97310-0100
(503) 378-4882

Pennsylvania

Community College of Beaver
County
Mr. Robert Powell
Assistant Professor
Aviation Sciences Center
125 Cessna Drive
Beaver Falls, PA 15010-1080
(412) 847-7000

Rhode Island

Warwick Public Schools
Mr. Anthony Gagliardi
Warwick Career & Tech School
575 Centerville Road
Warwick, RI 02886
(401) 737-3300

South Carolina

Dean Parnell Smith
Clinton Junior College
P.O. Box 968
Rock Hill, SC 29731
(803) 327-7402

South Dakota

Sisseton Wahperon Comm. College
Mr. Chip Harris, Director
Office of Planning and Development
Old Agency Box 689
Sisseton, SD 57262-0689
(605) 698-3966

Tennessee

Middle Tennessee State University
Dr. Wallace R. Maples, Chairman
Aerospace Department
East Main Street
P.O. Box 67 MTSU
Murfreesboro, TN 37132
(615) 898-2788

Texas

Texas Southern University
Mr. Isaac Nettey, Director
Airway Science Program
3100 Cleburne Avenue
Houston, TX 77004
(713) 639-1847

University of Texas at El Paso
Dr. Jim Milson, Chairman
Room 403, Education Building
El Paso, TX 79968-0574
(915) 747-5426

Texas State Technical College
Campus Librarian
Aerospace Technologies
3801 Campus Drive
Waco, TX 78708
(817) 799-3611

Palo Alto College
Mr. Bruce Hoover
Aviation Department
1400 West Villarette
San Antonio, TX 72884
(512) 921-5162

Frontiers of Flight Museum
Mr. Olin Lancaster, Director
Love Field Terminal, BL-38
Dallas, TX 75235
(214) 350-3600

Utah

Utah Valley State College
Dr. P.R. "Ron" Smart
Director, Aviation Science Dept.
800 West 1200 South
Orem, Utah 4058-5999
(801) 222-8000 ext. 8436

Vermont

St. Johnsbury Academy
Mr. John Barney
Vocational Director
St. Johnsbury, VT 05816
(802) 748-8171

State of Vermont
Mr. Rick Sylvester, Aviation Instr.
RM A-322 Burlington Tech. Center
52 Institute Road
Burlington, VT 05401
(808) 864-8424

Virginia

Virginia Aviation Museum
Ms. Betty P. Wilson
5701 Huntsman Road
Sandston, VA 23150-1946
(804) 225-3783

Washington

Museum of Flight
Mr. Gregory Moyce
Education Program Manager
9404 East Marginal Way South
Seattle, WA 98108
(206) 764-5700

West Virginia

Salem-Teikyo University
Dr. Ronald Ohl, President
223 West Main Street
Salem, WV 26426
(304) 782-5234

Fairmont State College
Mr. Charles W. Wite, Director
Mid-Atlantic Aviation Training &
Education Center
1201 Locust Avenue
Fairmont, WV 26554
(304) 367-4156

Wisconsin

Experimental Aircraft Association
Mr. Chuck Larsen
EAA Aviation Center
3000 Poberezny Road
Oshkosh, WI 54903-3065
(414) 426-4800

Department of Transportation
Bureau of Aeronautics
Mr. Duane Esse
4802 Sheboygan Avenue
P.O. Box 7914
Madison, WI 53707-7914
(608) 266-3351

University of Wisconsin-Superior
Mr. Michael J. Wallschlaeger
Chairman
Division of Education
1800 Grand Avenue
Superior, WI 54880-2898
(715) 394-8309

Wyoming

Campbell County School District
Media Services
Ms. Toni Brown
525 W. Lakeway Road
Gillette, WY 82718
(307) 682-3411