



Operator's Manual

Serial Number Range

GSTM-2669RT

from GS69F-18000
from GS69M-101

GSTM-3369RT

GSTM-4069RT

AUS
Australia

with
Maintenance
Information

Original Instructions
Second Edition
Fifth Printing
Part No. 1305661GT

Contents

Introduction	1
Symbol and Hazard Pictorials Definitions.....	5
General Safety	8
Personal Safety.....	11
Work Area Safety	12
Legend	20
Controls.....	21
Inspections	26
Operating Instructions.....	37
Transport and Lifting Instructions	44
Maintenance	47
Specifications.....	51

Copyright © 2011 by Terex Corporation

Second Edition: Fifth Printing, October 2024

Genie is a registered trademark of Terex South Dakota, Inc. in the U.S.A. and many other countries.

“GS” is a trademark of Terex South Dakota, Inc.

These machines comply with AS 1418.10



Introduction

About this manual

Genie appreciates your choice of our machine for your application. Our number one priority is user safety, which is best achieved by our joint efforts. This book is an operation and daily maintenance manual for the user or operator of a Genie machine.

This manual should be considered a permanent part of your machine and should remain with the machine at all times. If you have any questions, contact Genie.

Product Identification

The machine serial number is located on the serial label.

Serial number stamped on chassis

Serial label (located under cover)

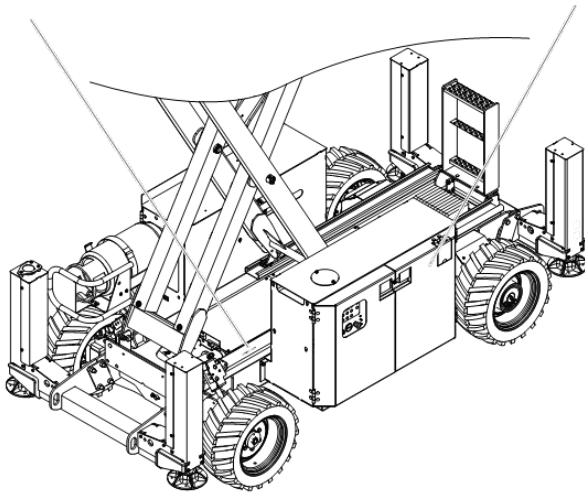

Intended Use and Familiarization Guide

The intended use of this machine is to lift personnel, including tools, and materials to an aerial work site. Before operating the machine, it's the operator's responsibility to read and understand this familiarization guide.

- Each person must be trained to operate a Mobile Elevating Work Platform (MEWP).
- Familiarization with the MEWP must be given to each person who is authorized, competent and trained.
- Only trained and authorized personnel should be permitted to operate the machine.
- The operator is responsible to read, understand, and obey the manufacturer's instructions and safety rules provided in the Operator's Manual.
- The Operator's Manual is located in the manual storage container, at the platform.
- For specific product applications, see **Contacting The Manufacturer**.

Introduction

Platform controls symbology and related machine movement:

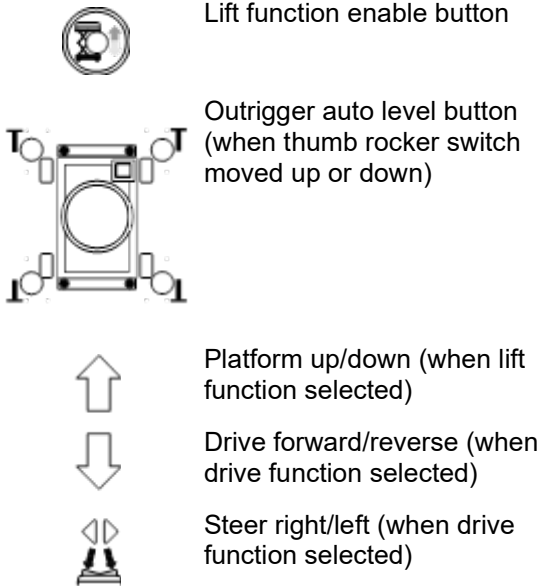

Ground controls symbology and related machine movement:

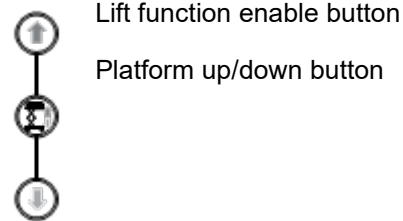

Sequential functions and movement:

- Drive and steer.

Interlocked functions:

- Elevated drive speed.
- Elevated drive in an off-level condition.
- All platform and ground controls.

Limitations of use:

- The intended use of this machine is to lift personnel, including tools, and materials to an aerial work site.
- Do not elevate the platform unless the machine is on firm level ground.

Introduction

Bulletin Distribution and Compliance

Safety of product users is of paramount importance to Genie. Various bulletins are used by Genie to communicate important safety and product information to dealers and machine owners.

The information contained in the bulletins is tied to specific machines using the machine model and serial number.

Distribution of bulletins is based on the most current owner on record along with their associated dealer, so it is important to register your machine and keep your contact information up to date.

To ensure safety of personnel and the reliable continued operation of your machine, be sure to comply with the action indicated in a respective bulletin.

To view any open bulletins for your machine, visit us on the web at www.genielift.com.

Contacting the Manufacturer

At times it may be necessary to contact Genie. When you do, be ready to supply the model number and serial number of your machine, along with your name and contact information. At minimum, Genie should be contacted for:

Accident reporting

Questions regarding product applications and safety

Standards and regulatory compliance information

Current owner updates, such as changes in machine ownership or changes in your contact information. See Transfer of Ownership, below.

Transfer of Machine Ownership

Taking a few minutes to update owner information will ensure that you receive important safety, maintenance and operating information that applies to your machine.

Please register your machine by visiting us on the web at www.genielift.com or by calling us toll free at 1-800-536-1800.



Introduction



Danger

Failure to obey the instructions and safety rules in this manual will result in death or serious injury.

Do Not Operate Unless:

- You learn and practice the principles of safe machine operation contained in this operator's manual.
 - 1 Avoid hazardous situations.**

Know and understand the safety rules before going on to the next section.

 - 2 Always perform a pre-operation inspection.
 - 3 Always perform function tests prior to use.
 - 4 Inspect the workplace.
 - 5 Only use the machine as it was intended.
- You read, understand and obey the manufacturer's instructions and safety rules—safety and operator's manuals and machine decals.
- You read, understand and obey employer's safety rules and worksite regulations.
- You read, understand and obey all applicable governmental regulations.
- You are properly trained to safely operate the machine.

Safety Sign Maintenance

Replace any missing or damaged safety signs. Keep operator safety in mind at all times. Use mild soap and water to clean safety signs. Do not use solvent-based cleaners because they may damage the safety sign material.

Hazard Classification

Decals on this machine use symbols, color coding, and signal words to identify the following:



Safety alert symbol—used to alert you to potential personal injury hazards. Obey all safety messages that follow this symbol to avoid possible injury or death.



Indicates a hazardous situation which, if not avoided, will result in death or serious injury.



Indicates a hazardous situation which, if not avoided, could result in death or serious injury.























Indicates a hazardous situation which, if not avoided, could result in minor or moderate injury.



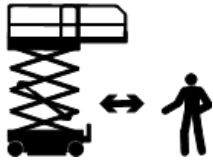













Indicates a property damage message.



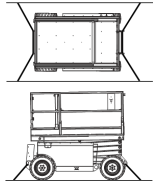

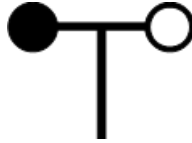

Symbol and Hazard Pictorials Definitions

				
Read the operator's manual	Read the service manual	Crush hazard	Crush hazard	Collision hazard
				
Tip-over hazard	Tip-over hazard	Tip-over hazard	Tip-over hazard	Electrocution hazard
				
Electrocution hazard	Explosion hazard	Fire hazard	Burn hazard	Skin injection hazard
				
Engage safety arm	Keep away from moving parts	Keep clear of outriggers and tires	Move machine to level ground	Close chassis tray

Symbol and Hazard Pictorials Definitions

 <p>Lower the platform.</p>	 <p>Do not set up where it cannot be leveled with outriggers</p>	 <p>Maintain required clearance</p>	 <p>Access by trained and authorized personnel only</p>	 <p>Use a piece of cardboard or paper to search for leaks</p>
 <p>Chock the wheels</p>	 <p>Release brakes</p>	 <p>Tiedown</p>	 <p>Lanyard anchorage points</p>	 <p>No smoking</p>
 <p>Wheel load</p>	 <p>Transport diagram</p>	 <p>Manual force</p>	 <p>Wind speed</p>	 <p>Outrigger load</p>

Symbol and Hazard Pictorials Definitions

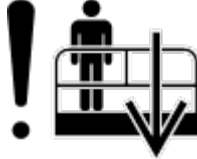
 <p>Voltage rating for power to platform</p>	 <p>Pressure rating for air line to platform</p>	 <p>Maximum capacity</p>	 <p>Fall hazard</p>	 <p>Platform overloaded</p>
 <p>Crushing hazard</p>	 <p>Auxiliary lowering</p>			

General Safety

1294707

⚠ DANGER

Electrocution Hazard
Death or injury can result from contacting electric power lines. This machine is not electrically insulated. Always contact the electric power line owner. The electric power shall be disconnected or the power lines moved or insulated before machine operations begin.

Line Voltage	Reached Clearance
0 to 50kV	10.6 3.55 m
50kV to 200kV	15.6 4.80 m
200kV to 350kV	20.6 6.70 m
350kV to 500kV	24.6 7.87 m
500kV to 750kV	29.6 9.67 m
750kV to 1000kV	34.6 11.27 m

1311471

⚠ DANGER

Tip-over Hazard
Death or serious injury can result from contact with moving scissor arms.

This machine is equipped with foam-filled tires. Wheel weight and proper counterweight configuration are critical to stability.

31060

⚠ DANGER

Tip-over Hazard
Always or disabling sensors or limit switches can result in machine tip-over. Machine tip-over will result in death or serious injury.

Do not alter or disable sensors and/or limit switches.

229827

⚠ WARNING

Burn Hazard
Contact with hot surfaces can result in death or injury.

Stay clear of hot surfaces. Allow machine to cool before servicing.

229827

⚠ WARNING

Burn Hazard
Contact with hot surfaces can result in death or injury.

Stay clear of hot surfaces. Allow machine to cool before servicing.

1299263

⚠ DANGER

Tip-over Hazard
Do not use air-filled tires.

This machine is equipped with foam-filled tires. Wheel weight and proper counterweight configuration are critical to stability.

RT Tires	RT Tires
110 500: 20 X 120090	110 500: 20 X 120090
Foam-filled Tires	Foam-filled Tires
Minimum New Weight	Minimum New Weight
17,218 / 80.3 kg	17,218 / 80.3 kg
Wheel Lug Torque	Wheel Lug Torque
Dry: 170 lbs-ft / 230 Nm	Dry: 170 lbs-ft / 230 Nm
Lubricated: 130 lbs-ft / 178 Nm	Lubricated: 130 lbs-ft / 178 Nm
Castle Nut Torque	Castle Nut Torque
See service manual for tightening procedures.	See service manual for tightening procedures.
Be sure spindle is properly installed.	Be sure spindle is properly installed.

1311471

⚠ DANGER

Tip-over Hazard
Death or serious injury can result from contact with moving scissor arms.

This machine is equipped with foam-filled tires. Wheel weight and proper counterweight configuration are critical to stability.

72186

⚠ WARNING

Crushing Hazard
Lowering the outriggers onto a person's foot may cause serious injury.

Stay clear. Be sure that nothing is under the outriggers before lowering.

72186

⚠ WARNING

Crushing Hazard
Lowering the outriggers onto a person's foot may cause serious injury.

Stay clear. Be sure that nothing is under the outriggers before lowering.

97602

⚠ WARNING

Explosion Hazard
Death or serious injury can result from the use of ether or other high energy starting aids.

Do not use ether or other high energy starting aids on machines equipped with glow plugs or grid heaters.

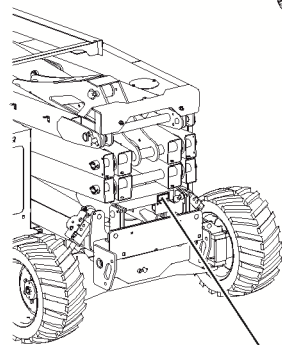

31060

⚠ DANGER

Tip-over Hazard
Always or disabling sensors or limit switches can result in machine tip-over. Machine tip-over will result in death or serious injury.

Do not alter or disable sensors and/or limit switches.

82561

⚠ DANGER

Crushing Hazard
Death or serious injury can result from contact with moving scissor arms.

Engage safety arm before performing maintenance or repair.

See service manual.

1263543

⚠ WARNING

Innovative operation or maintenance of this equipment can result in death or serious injury.

Always be trained and authorized personnel only.

31788

⚠ DANGER

Tip-over Hazard
Death or serious injury can result from contact with moving scissor arms.

This machine is equipped with foam-filled tires. Wheel weight and proper counterweight configuration are critical to stability.

General Safety

1294707

⚠ DANGER



Electrocution Hazard
Death or injury can result from contacting electric power lines.

This machine is not electrically insulated.

Always contact the electric power line owner. The electric power shall be disconnected or the power lines moved or insulated before machine operations begin.

Line voltage	Required clearance
0 to 50kV	10 ft 3.05 m
50kV to 200kV	15 ft 4.60 m
200kV to 350kV	20 ft 6.10 m
350kV to 575kV	26 ft 7.93 m
575kV to 725kV	35 ft 10.67 m
725kV to 1050kV	45 ft 13.72 m

114258

⚠ DANGER



Burn Hazard
Fuel and flames can explode and burn.

No smoking. No flames. STOP engine.

114258 A

72186

⚠ WARNING



Crushing hazard.
Lowering the outriggers onto a person's foot may cause serious injury.



Stay clear. Be sure that nothing is under the outriggers before lowering.

72186

⚠ WARNING



Crushing hazard.
Lowering the outriggers onto a person's foot may cause serious injury.



Stay clear. Be sure that nothing is under the outriggers before lowering.

1263543

⚠ WARNING



Improper operation or maintenance of this equipment can result in death or vehicle injury.



Attended by trained and authorized personnel only.

52865

⚠ WARNING



Annual Inspection Required
Failure to complete required inspections could result in death or serious injury.

Schedule maintenance Use the maintenance schedule that is included in the operator's manual or contact the appropriate service agency for repair parts.

Use the load capacity indicated on the machine's nameplate. Exceeding the load capacity could result in death or serious injury.

Date of Inspection	Inspector	Signature

82561

⚠ DANGER



Crushing Hazard
Death or serious injury can result from contact with moving scissor arms.



Engage safety arms before performing maintenance or repair.



See service manual.

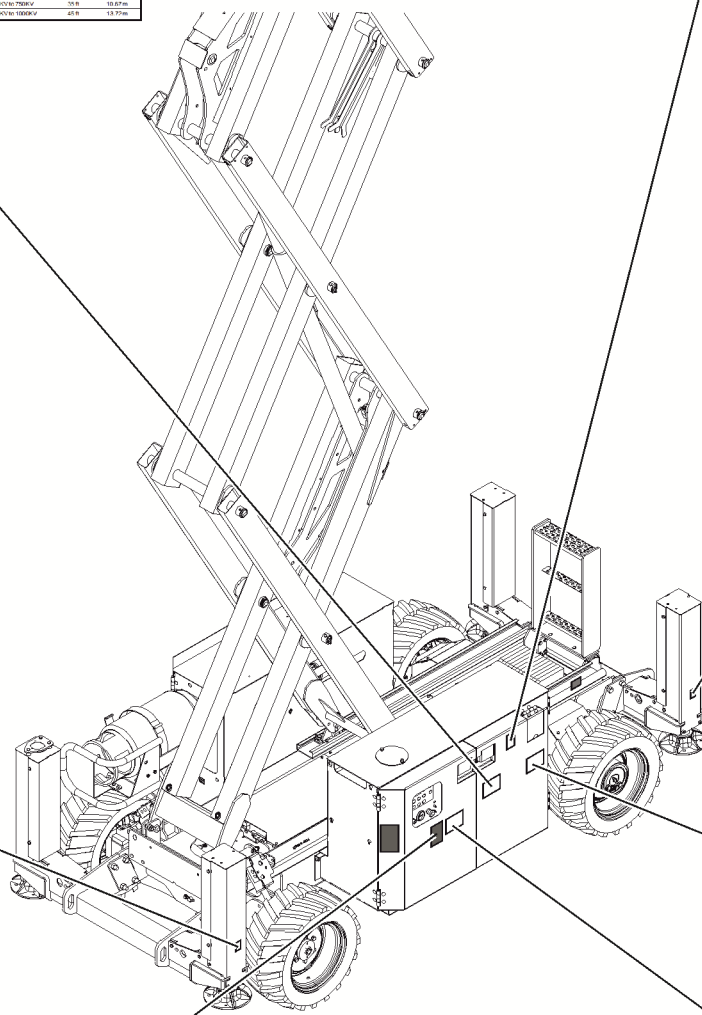

General Safety

44736

⚠ DANGER

Tip-over Hazard
If tilt-alarm sounds, unit is on a covered slope. Death or serious injury could occur.

1 Lower the platform.
2 Move the machine to level surface.

52494

⚠ WARNING

Creeching Hazard
Falling guard rails could cause injury.

Mobilizing on an uneven platform
Do not allow platform guard rails to fall.

1301840

⚠ DANGER

Indicator Light Flashing Red
When indicator light is flashing red, the machine is unstable and will tip over if you do not take the following actions:

Tip-over Hazard
Do not use platform. Platform could fall from a height and cause injury.

28236

⚠ WARNING

Read and understand Operator's Manual, Responsibilities Manual and Safety Manual and all safety signs before using or maintaining machine.
If you do not understand the information in the manuals, consult your supervisor, the owner or the manufacturer.

229915

⚠ DANGER

INSTRUCTIONS

Failure to read, understand and obey the safety rules and operating instructions of the scissor lift may result in death or serious injury.

Operating Instructions

Read and understand the Operator's Manual, Responsibilities Manual and Safety Manual and all safety signs before using or maintaining machine. If you do not understand the information in the manuals, consult your supervisor, the owner or the manufacturer.

1293165

⚠ DANGER

Tip-over Hazard
Tipping over the machine will result in death or serious injury.

Fall Hazard
Falling from the machine can result in death or serious injury.

Creep Hazard
Creep can result in death or serious injury.

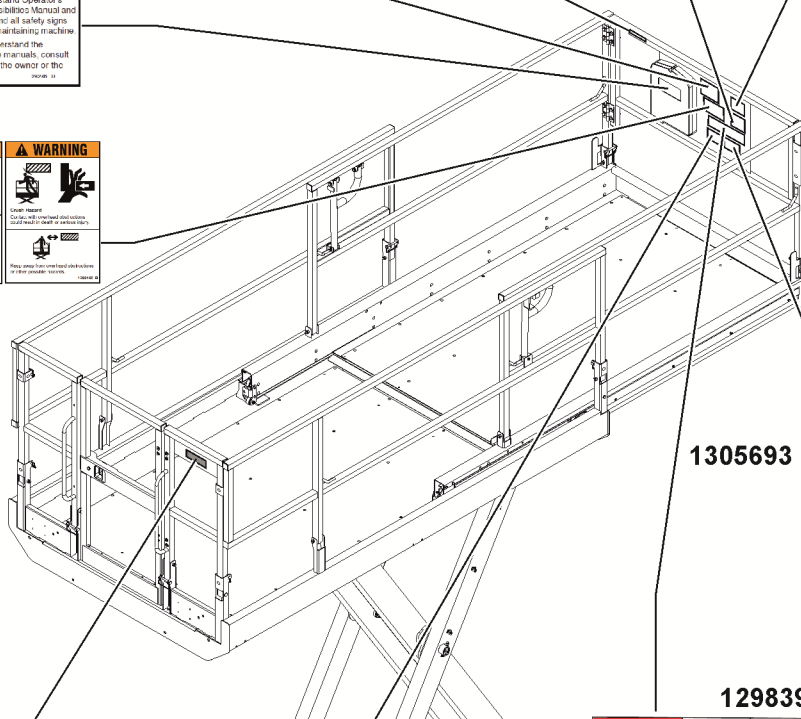

1305691 (GS-2669)

⚠ WARNING

Tip-over Hazard
Tipping over the machine will result in death or serious injury.

Machine movement
Machine movement can occur when machine is operated on a slope that exceeds the maximum slope rating. A warning horn will sound if the slope is too steep. Do not drive on a slope that could result in death or serious injury.

1305693 (GS-3369, GS-4069)

⚠ WARNING

Tip-over Hazard
Tipping over the machine will result in death or serious injury.

Machine movement
Machine movement can occur when machine is operated on a slope that exceeds the maximum slope rating. A warning horn will sound if the slope is too steep. Do not drive on a slope that could result in death or serious injury.

1298396 (GS-2669)

⚠ DANGER

Tip-over Hazard
Tipping over the machine will result in death or serious injury.

Maximum allowable wind speed: 28 mph / 12.5 m/s

Maximum allowable side force: 90 lbs / 400 N

Maximum capacity: 1500 lbs / 680 kg

Platform extended: Max. height: 15.5 ft / 4.72 m

1298397 (GS-3369)

⚠ DANGER

Tip-over Hazard
Tipping over the machine will result in death or serious injury.

Maximum allowable wind speed: 28 mph / 12.5 m/s

Maximum allowable side force: 90 lbs / 400 N

Maximum capacity: 1000 lbs / 454 kg

Platform extended: Max. height: 10.5 ft / 3.19 m

1298398 (GS-4069)

⚠ DANGER

Tip-over Hazard
Tipping over the machine will result in death or serious injury.

Maximum allowable wind speed: 28 mph / 12.5 m/s

Maximum allowable side force: 90 lbs / 400 N

Maximum capacity: 800 lbs / 363 kg

Platform extended: Max. height: 10.5 ft / 3.19 m

214725

⚠ WARNING

Fall Hazard
Falling can result in death or serious injury.

Wear approved personal fall protection equipment and achieve 100% tie-off when exiting and entering an elevated platform.
Read and understand the Operator's Manual.

1294707

⚠ DANGER

Electrocution Hazard
Electricity can result in death or serious injury.

Always lock the electrical power line cover. The electric cover should be disconnected or the power line removed or insulated before machine operation begins.



Personal Safety

Personal Fall Protection

Personal fall protection equipment (PFPE) is not required when operating this machine provided the operator remains inside the perimeter of the platform guardrail system. If PFPE is required by job site or employer rules, the following shall apply:

All PFPE must comply with applicable governmental regulations and must be inspected and used in accordance with the manufacturer's instructions.

Work Area Safety

⚠ Electrocuting Hazards

This machine is not electrically insulated and will not provide protection from contact with or proximity to electrical current.



Obey all local and governmental regulations regarding required clearance from electrical power lines. At a minimum, the required clearance contained in the chart below must be followed.

Line Voltage	Required Clearance	
0 to 50KV	10 ft	3.05 m
50 to 200KV	15 ft	4.60 m
200 to 350KV	20 ft	6.10 m
350 to 500KV	25 ft	7.62 m
500 to 750KV	35 ft	10.67 m
750 to 1000KV	45 ft	13.72 m

Allow for platform movement, electrical line sway or sag, and beware of strong or gusty winds.



Keep away from the machine if it contacts energized power lines. Personnel on the ground or in the platform must not touch or operate the machine until energized power lines are shut off.

Do not operate the machine during lightning or storms.

Do not use the machine as a ground for welding.

⚠ Tip-over Hazards

Occupants, equipment and materials shall not exceed the maximum platform capacity or the maximum platform capacity of the platform extension.

Maximum capacity

Model	Platform extended			Maximum occupants
	Platform retracted	Platform only	Extension only	
GS-2669RT	1500 lbs/ 680 kg	1200 lbs/ 544 kg	300 lbs/ 136 kg	4
GS-3369RT	1000 lbs/ 454 kg	700 lbs/ 318 kg	300 lbs/ 136 kg	Indoor – 4 Outdoor – 2
GS-4069RT	800 lbs/ 363 kg	500 lbs/ 227 kg	300 lbs/ 136 kg	Indoor – 3 Outdoor – 2

Platform retracted



Platform extended



Extension only

Platform only

Work Area Safety



Do not raise the platform unless the machine is on a firm, level surface.



Do not depend on the tilt alarm as a level indicator. The tilt alarm sounds on the chassis only when the machine is on a severe slope.

If the tilt alarm sounds:

Lower the platform. Move the machine to a firm, level surface. If the tilt alarm sounds when the platform is raised, use extreme caution to lower the platform.

Do not alter or disable the limit switches or angle sensor.

Do not drive over 0.3 mph / 0.48 km/h with the platform raised.

Do not raise the platform when wind speeds may exceed 28 mph / 12.5 m/s. If wind speeds exceed 28 mph / 12.5 m/s when the platform is raised, lower the platform and do not continue to operate the machine.



Do not operate the machine in strong or gusty winds. Do not increase the surface area of the platform or the load. Increasing the area exposed to the wind will decrease machine stability.



Use extreme care and slow speeds while driving the machine in the stowed position across uneven terrain, debris, unstable or slippery surfaces and near holes and drop-offs.

Do not use the platform controls to free a platform that is caught, snagged, or otherwise prevented from normal motion by an adjacent structure. All personnel must be removed from the platform before attempting to free the platform using the ground controls.

Work Area Safety

Do not drive the machine on or near uneven terrain, unstable surfaces or other hazardous conditions with the platform raised.

Do not use the machine as a crane.

Do not push the machine or other objects with the platform.

Do not contact adjacent structures with the platform.

Do not tie the platform to adjacent structures.

Do not place loads outside the platform perimeter.



Do not push off or pull toward any object outside of the platform.

Maximum manual force

GS-2669RT – 4 person	90 lbs/400 N
GS-3369RT – 4 person, indoor	90 lbs/400 N
GS-3369RT – 2 person, outdoor	90 lbs/400 N
GS-4069RT – 3 person, indoor	90 lbs/400 N
GS-4069RT – 2 person, outdoor	90 lbs/400 N

Do not alter or disable machine components that in any way affect safety and stability.

Do not replace items critical to machine stability with items of different weight or specification.

Do not modify or alter a mobile elevating work platform without prior written permission from the manufacturer. Mounting attachments for holding tools or other materials onto the platform, toeboards, or guard rail system can increase the weight in the platform and the surface area of the platform or the load.



Do not place or attach fixed or overhanging loads to any part of this machine.



Do not place ladders or scaffolds in the platform or against any part of this machine.

Do not transport tools and materials unless they are evenly distributed and can be safely handled by person(s) in the platform.

Do not use the machine on a moving or mobile surface or vehicle.

Be sure all tires are in good condition, castle nuts are properly tightened and cotter pins are properly installed.

Work Area Safety

▲ Crushing Hazard

Keep hands and limbs out of scissors.

Keep hands clear when folding rails.

Do not work under the platform or in the scissor links without the safety arm in place.

Use common sense and planning when operating the machine with the controller from the ground. Maintain safe distances between the operator, the machine and fixed objects.

▲ Operation on Slopes Hazards

Do not drive the machine on a slope that exceeds the slope and side slope rating of the machine. Slope rating applies to machines in the stowed position.

Maximum slope rating, stowed position

GS-2669RT	40% (22°)
GS-3369RT	35% (19°)
GS-4069RT	35% (19°)

Maximum side slope rating, stowed position

GS-2669RT	40% (22°)
GS-3369RT	35% (19°)
GS-4069RT	35% (19°)

Note: Slope rating is subject to ground conditions with one person in the platform and adequate traction. Additional platform weight may reduce slope rating. See Driving on a Slope in the Operating Instructions section.

Work Area Safety

▲ Fall Hazards

The guard rail system provides fall protection. If occupant(s) of the platform are required to wear personal fall protection equipment (PFPE) due to job site or employer rules, PFPE and its use shall be in accordance with the PFPE manufacturer's instructions and applicable governmental requirements. Use approved lanyard attachment point provided.



Do not sit, stand, or climb on the platform guard rails. Maintain a firm footing on the platform floor at all times.



Do not climb down from the platform when raised.

Keep the platform floor clear of debris.

Close the entry gate before operating.

Do not operate the machine unless the guard rails are properly installed and the entry is secured for operation.

Do not enter or exit the platform unless the machine is in the stowed position.

Hazards related with the specific product application of exiting at height have been considered in the design of the machine, for further information contact Genie (see section Contacting the Manufacturer).

Work Area Safety

▲ Collision Hazards



Be aware of limited sight distance and blind spots when driving or operating.

Be aware of extended platform position when moving the machine.

The machine must be on a level surface or secured before releasing the brakes.

Operators must comply with employer, job site, and governmental rules regarding use of personal protective equipment.



Check the work area for overhead obstructions or other possible hazards.



Be aware of crushing hazards when grasping the platform guard rail.

Observe and use color-coded direction arrows on the platform controls and the platform decal plate for drive and steer functions.



Do not lower the platform unless the area below is clear of personnel and obstructions.



Limit travel speed according to the condition of the ground surface, congestion, slope, location of personnel, and any other factors which may cause collision.

Do not operate a machine in the path of any crane or moving overhead machinery unless the controls of the crane have been locked out and/or precautions have been taken to prevent any potential collision.

No stunt driving or horseplay while operating a machine.

Work Area Safety

▲ Bodily Injury Hazard

Always operate the machine in a well-ventilated area to avoid carbon monoxide poisoning.

Do not operate the machine with a hydraulic oil or air leak. An air leak or hydraulic leak can penetrate and/or burn skin.

Improper contact with components under any cover will cause serious injury. Only trained maintenance personnel should access compartments. Access by the operator is only advised when performing a pre-operation inspection. All compartments must remain closed and secured during operation.

▲ Component Damage Hazards

Do not use any battery or charger greater than 12V to jump-start the engine.

Do not use the machine as a ground for welding.

Do not operate the machine in locations where extremely high magnetic fields may be present.

▲ Explosion and Fire Hazards

Do not start the engine if you smell or detect liquid petroleum gas (LPG), gasoline, diesel fuel or other explosive substances.

Do not refuel the machine with the engine running.

Refuel the machine and charge the battery only in an open, well-ventilated area away from sparks, flames and lighted tobacco.

Do not operate the machine in hazardous locations or locations where potentially flammable or explosive gases or particles may be present.

Do not spray ether into engines equipped with glow plugs.

▲ Damaged Machine Hazards

Do not use a damaged or malfunctioning machine.

Conduct a thorough pre-operation inspection of the machine and test all functions before each work shift. Immediately tag and remove from service a damaged or malfunctioning machine.

Be sure all maintenance has been performed as specified in this manual and the appropriate Genie service manual.

Be sure all decals are in place and legible.

Be sure the operator's manual is complete, legible, and in the storage container located on the machine.

Work Area Safety

▲ Outrigger Safety

Tip-over Hazards

Do not lower the outriggers unless the machine is on a firm surface. Avoid drop-offs, holes, unstable or slippery surfaces and other possible hazardous conditions.

Do not raise the platform unless the machine is level. Do not set the machine up on a surface where it cannot be leveled using only the outriggers.

Do not raise the platform unless all four outriggers are properly lowered, the footpads are in firm contact with the ground and the machine is level.

Do not adjust the outriggers while the platform is raised.

Do not drive while the outriggers are lowered.

▲ Battery Safety

Burn Hazards



Batteries contain acid. Always wear protective clothing and eye wear when working with batteries.

Avoid spilling or contacting battery acid. Neutralize battery acid spills with baking soda and water.

Do not expose the batteries or the charger to water or rain during charging.

Explosion Hazards



Keep sparks, flames, and lighted tobacco away from batteries. Batteries emit explosive gas.

The battery tray should remain open during the entire charging cycle.

Do not contact the battery terminals or the cable clamps with tools that may cause sparks.

Component Damage Hazard

Do not use any battery charger greater than 24V to charge the batteries.

Legend

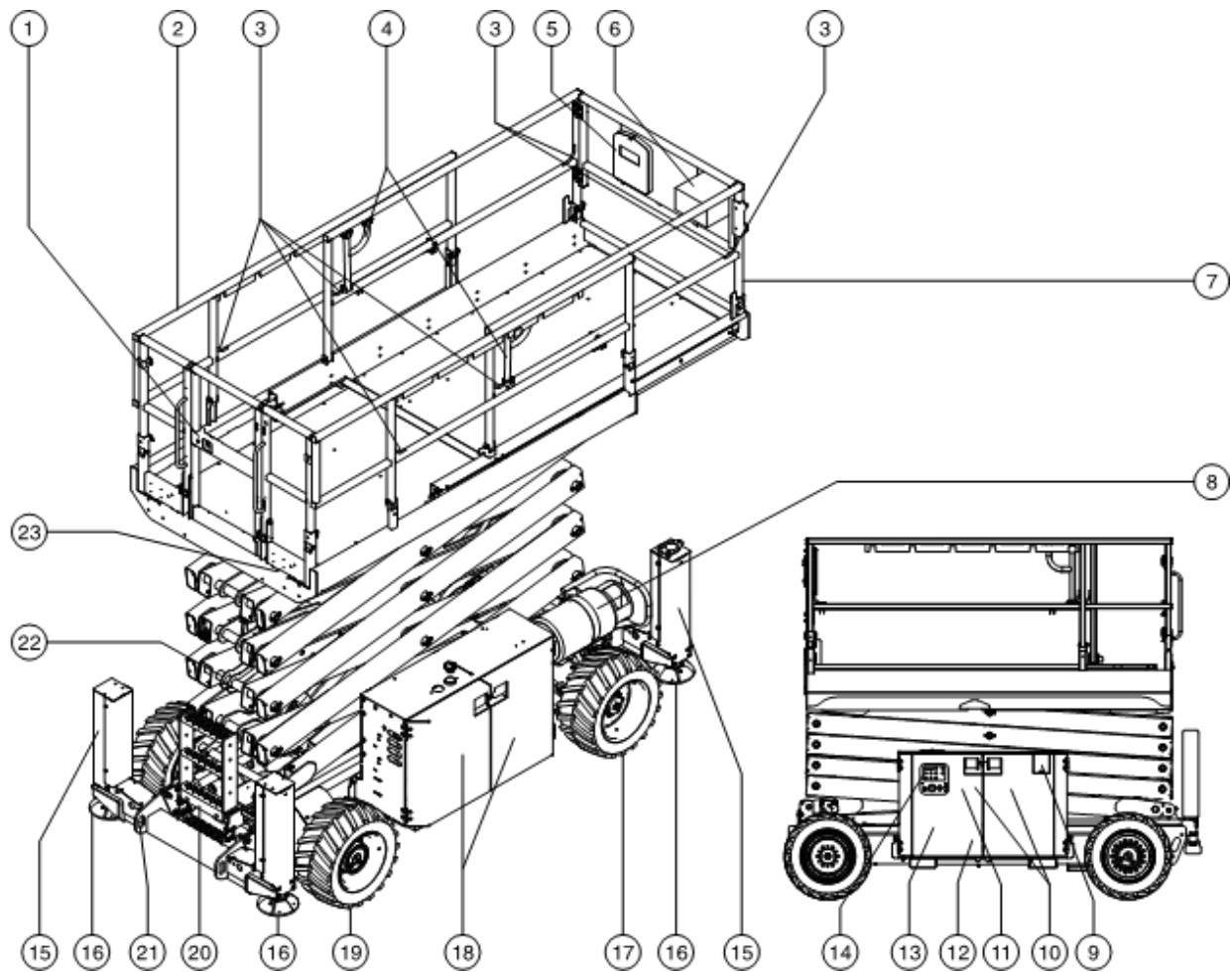

- | | | |
|----------------------------------|--|--|
| 1 Platform entry gate | 10 Ground controls side covers | 16 Outrigger footpad (if equipped with outriggers) |
| 2 Platform guard rails | 11 Hydraulic tank (behind cover) | 17 Steer tire |
| 3 Lanyard anchorage points | 12 Tilt alarm (behind cover) | 18 Engine side covers |
| 4 Platform extension lock handle | 13 Hydraulic oil level indicator (behind cover) | 19 Non-steer tire |
| 5 Manual storage container | 14 Ground controls with LCD readout screen | 20 Entry ladder |
| 6 Platform controls | 15 Outrigger housing (if equipped with outriggers) | 21 Transport tie-down |
| 7 Platform extension | | 22 Safety arm |
| 8 LPG tank | | 23 GFCI outlet |
| 9 Fuel tank | | |



Controls

The ground control station is to be used as a means to raise the platform for function tests and for storage purposes. The ground control station can be used in the event of an emergency to rescue an incapacitated person in the platform.

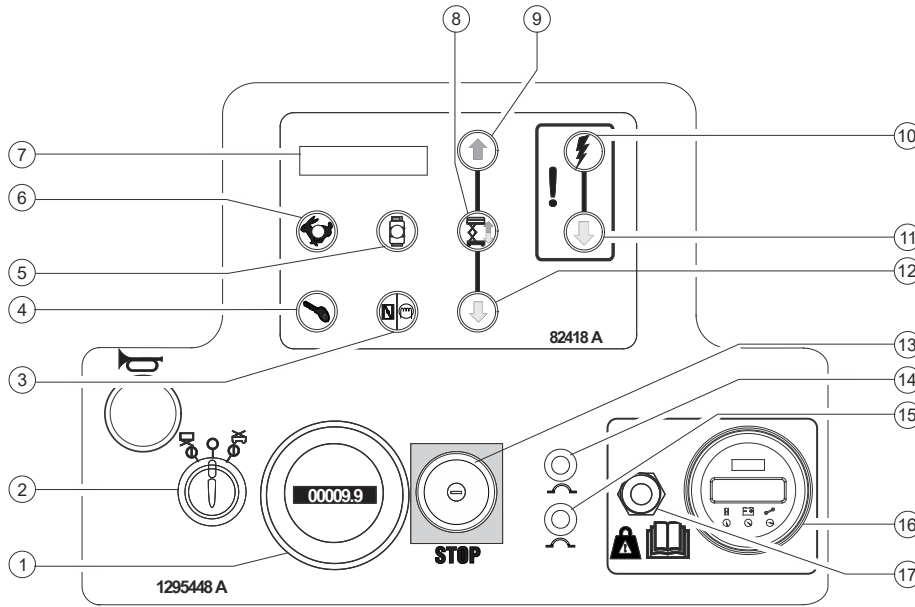

or

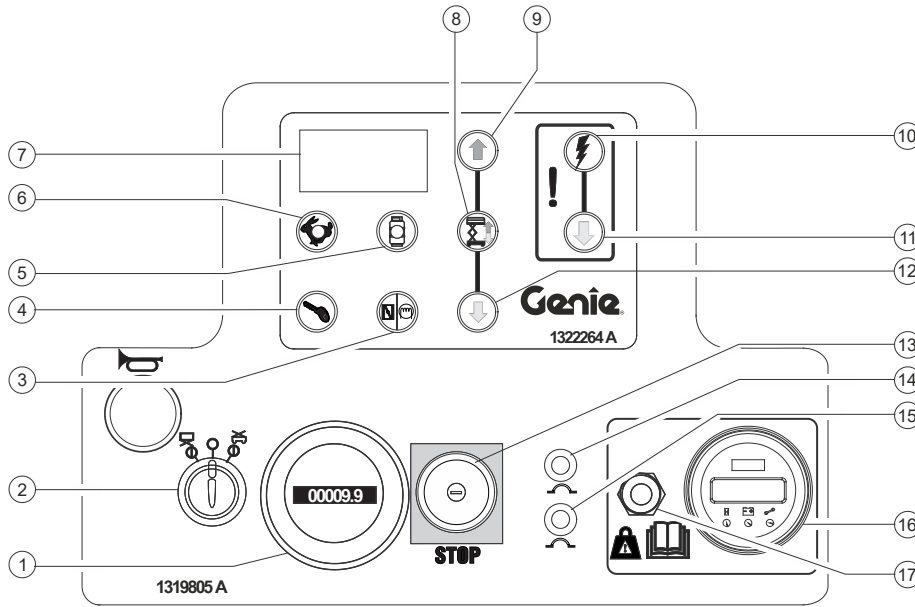

Ground Control Panel



Controls

Ground Control Panel

1 Hour meter

The hour meter displays the number of hours the machine has operated.

diagnostic display

The diagnostic display shows engine hours, RPM, oil pressure, system voltage, and coolant temperature.

2 Key switch for platform/off/ground selection

Turn the key switch to the platform position and the platform controls will operate. Turn the key switch to the off position and the machine will be off. Turn the key switch to the ground position and the ground controls will operate.

3 Gasoline/LPG models: Choke button

Press this button to activate the choke.

Diesel models: Glow plug button

Press this button to activate the glow plugs.

4 Engine start button

Press this button to start the engine.

5 Gasoline/LPG models: LPG select button with indicator light

Press this button to select fuel. Light on indicates that LPG is selected. Light off indicates gasoline is selected.

6 Engine idle select button with indicator light

Press this button to select the engine idle setting. Light on indicates high idle is selected. Light off indicates low idle is selected.

7 LCD readout screen

8 Lift function enable button

Press this button to activate the lift function.

9 Platform up button

Press this button and the platform will raise.

10 Auxiliary power function enable button

Press this button to activate the auxiliary power function.

11 Auxiliary lowering down button

Press this button to activate the auxiliary lowering down function.

12 Platform down button

Press this button and the platform will lower.

13 Red Emergency Stop button

Push in the red Emergency Stop button to the off position to stop all functions. Pull out the red Emergency Stop button to the on position to operate the machine.

14 20A circuit breaker for controls circuit

15 15A breaker for controls circuit

16 Load Sense Calibration display (see service manual for details)

17 Load Sense Calibration switch (see service manual for details)

Controls

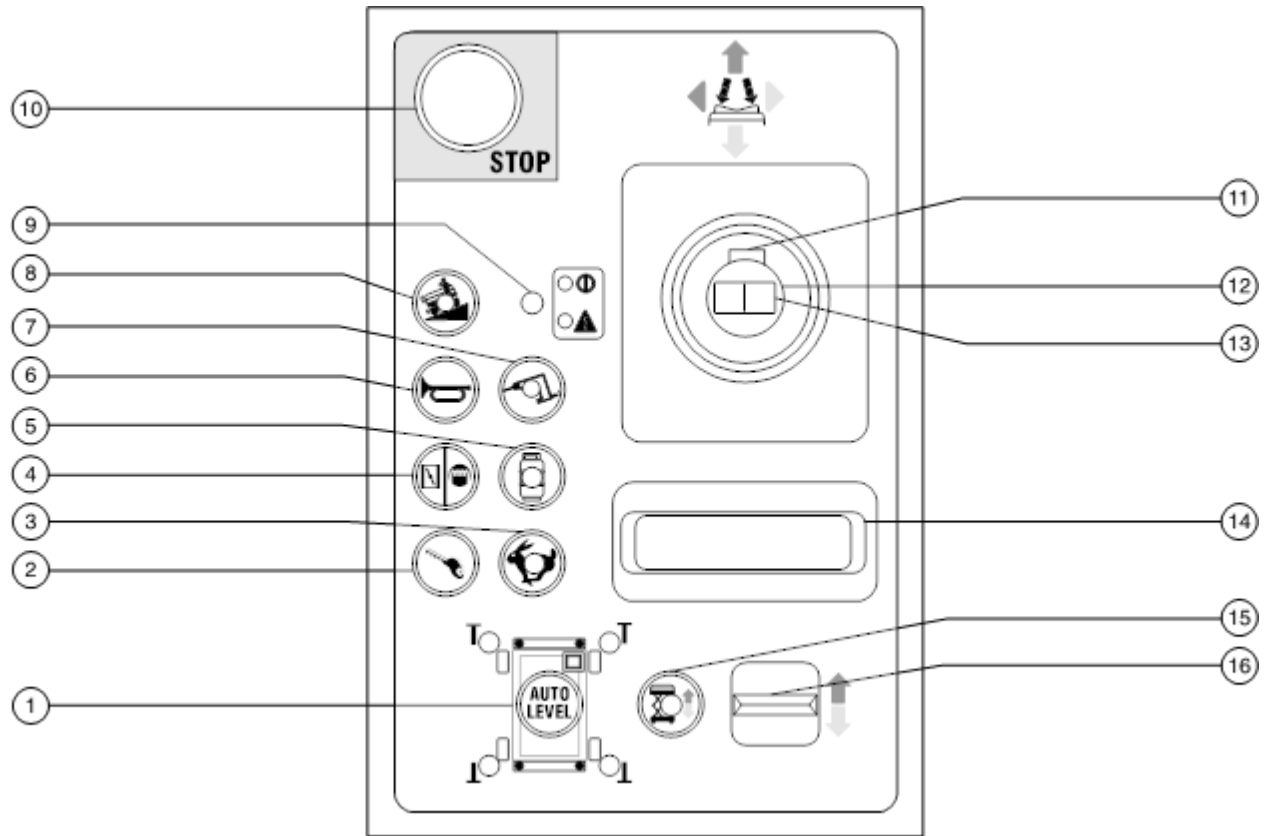

Platform Control Panel

Controls

Platform Control Panel

- 1 Outrigger auto level button
Press this button to activate the auto level function.
- 2 Engine start button
Press this button to start the engine.
- 3 Engine idle select button with indicator light
Press this button to select the engine idle setting. Light on indicates high idle is selected. Light off indicates low idle is selected.
- 4 Gasoline/LPG models: Choke button
Press this button to aid in starting the engine in cold conditions.
Diesel models: Glow plug button
Press this button to aid in starting the engine in cold conditions.
- 5 Gasoline/LPG models: LPG select button with indicator light
Press this button to select LPG.
- 6 Horn button
Press this button and the horn will sound. Release the button and the horn will stop.
- 7 Generator select button with indicator light
Press this button to turn the generator on. Indicator light will be on. Press the button again to turn the generator off.
- 8 Machine on incline button with indicator light: Low speed operation for inclines
Press this button to select low speed operation for inclines.
- 9 Green power light/Red error indicator light
Green power light is on when Red Emergency Stop button is pulled out to the on position.
If red error indicator light is on, push in and pull out the Red Emergency Stop button to set the system. If the light stays red, tag and remove the machine from service.
- 10 Red Emergency Stop button
Push in the red Emergency Stop button to the off position to stop all functions and turn the engine off. Pull out the red Emergency Stop button to the on position to operate the machine.
- 11 Function enable switch
Press and hold the function enable switch to enable the drive function.
- 12 Proportional control handle for drive function
Move the control handle in the direction indicated by the blue arrow on the control panel and the machine will move in the direction that the blue arrow points. Move the control handle in the direction indicated by the yellow arrow on the control panel and the machine will move in the direction that the yellow arrow points.

Controls

13 Thumb rocker switch for steer function

Press the left side of the thumb rocker and the machine will steer to the left.

Press the right side of the thumb rocker and the machine will steer to the right.

14 Wrist rest

15 Lift function enable button with indicator light

Press this button to enable the lift function.

16 Proportional rocker switch for outrigger up/down and platform up/down

With the auto level button indicator light on, move the rocker switch up and the outriggers will raise. Move the rocker switch down and the outriggers will lower.

With the lift function enable button indicator light on, move the rocker switch up and the platform will raise. Move the rocker switch down and the platform will lower.

Inspections



Do Not Operate Unless:

- You learn and practice the principles of safe machine operation contained in this operator's manual.
 - 1 Avoid hazardous situations.
 - 2 Always perform a pre-operation inspection.**
- Know and understand the pre-operation inspection before going on to the next section.**
 - 3 Always perform function tests prior to use.
 - 4 Inspect the workplace.
 - 5 Only use the machine as it was intended.

Pre-operation Inspection Fundamentals

It is the responsibility of the operator to perform a pre-operation inspection and routine maintenance.

The pre-operation inspection is a visual inspection performed by the operator prior to each work shift. The inspection is designed to discover if anything is apparently wrong with a machine before the operator performs the function tests.

The pre-operation inspection also serves to determine if routine maintenance procedures are required. Only routine maintenance items specified in this manual may be performed by the operator.

Refer to the list on the next page and check each of the items.

If damage or any unauthorized variation from factory delivered condition is discovered, the machine must be tagged and removed from service.

Repairs to the machine may only be made by a qualified service technician, according to the manufacturer's specifications. After repairs are completed, the operator must perform a pre-operation inspection again before going on to the function tests.

Scheduled maintenance inspections shall be performed by qualified service technicians, according to the manufacturer's specifications.

Obey all local and governmental regulations regarding examinations and tests.

Inspections

Pre-operation Inspection

- Be sure that the operator's manual is complete, legible and in the storage container located in the platform.
- Be sure that all decals are legible and in place. See Inspections section.
- Check for hydraulic oil leaks and proper oil level. Add oil if needed. See Maintenance section.
- Check for battery fluid leaks and proper fluid level. Add distilled water if needed. See Maintenance section.
- Check for engine oil leaks and proper oil level. Add oil if needed. See Maintenance section.
- Check for engine coolant leaks and proper level of coolant. Add coolant if needed. See Maintenance section.

Check the following components or areas for damage, improperly installed, or missing parts and unauthorized modifications:

- Electrical components, wiring, and electrical cables
- Hydraulic hoses, fittings, cylinders, and manifolds
- Drive motors
- Wear pads
- Tires and wheels
- Limit switches, angle sensor, alarms and horn
- Alarms and beacons (if equipped)
- Nuts, bolts and other fasteners
- Brake release components

- Safety arm
- Platform extension
- Scissor pins and retaining fasteners
- Platform control joystick
- Outrigger housing and footpads (if equipped)
- Fuel and hydraulic tanks
- Engine and related components
- Platform entry gate
- Generator (if equipped)

Check entire machine for:

- Cracks in welds or structural components
- Dents or damage to machine
- Excessive rust, corrosion or oxidation
- Verify that all structural and other critical components are present and all associated fasteners and pins are in place and properly tightened.
- Be sure side rails are installed and bolts are fastened.

Note: If the platform must be raised to inspect the machine, make sure the safety arm is in place. See Operating Instructions section.

Inspections



Do Not Operate Unless:

- You learn and practice the principles of safe machine operation contained in this operator's manual.
 - 1 Avoid hazardous situations.
 - 2 Always perform a pre-operation inspection.
 - 3 Always perform function tests prior to use.**

Know and understand the function tests before going on to the next section.

- 4 Inspect the workplace.
- 5 Only use the machine as it was intended.

Function Test Fundamentals

The function tests are designed to discover any malfunctions before the machine is put into service. The operator must follow the step-by-step instructions to test all machine functions.

A malfunctioning machine must never be used. If malfunctions are discovered, the machine must be tagged and removed from service. Repairs to the machine may only be made by a qualified service technician, according to the manufacturer's specifications.

After repairs are completed, the operator must perform a pre-operation inspection and function tests again before putting the machine into service.

Inspections

At the Ground Controls

- 1 Select a test area that is firm, level and free of hazards.
- 2 Pull out the platform and ground red Emergency Stop button to the on position.
- 3 Turn the key switch to ground control.
- ⦿ Result: The LCD screen will come on and display SYSTEM READY.

Note: In cold climates, the LCD readout screen will need to warm up before the display appears.

- 4 Start the engine. See Operating Instructions section.

Test Emergency Stop

- 5 Push in the red Emergency Stop button to the off position.
- ⦿ Result: The engine should shut off and no functions should operate.
- 6 Pull out the red Emergency Stop button to the on position and restart the engine.

Test the Up/Down Functions

The audible warnings on this machine and the standard horn all come from the same central alarm. The horn is a constant tone. The descent alarm sounds at 60 beeps per minute. The alarm that goes off when the machine is not level sounds at 180 beeps per minute.

- 7 Do not press the lift function enable button. Press and hold the platform up button.



- ⦿ Result: The platform should not raise.
- 8 Press and hold the lift function enable button. Press and hold the platform up button.
- ⦿ Result: The platform should raise.
- 9 Press and hold the lift function enable button. Press and hold the platform down button.
- ⦿ Result: The platform should lower. The descent alarm should sound while the platform is lowering.

Inspections

Test the Tilt Sensor Operation

Note: Perform this test from the ground with the platform controller. Do not stand in the platform.

- 10 Fully lower the platform.
- 11 Place a 2x4 or similar piece of wood under both wheels on one side and drive the machine up onto them.
- 12 Raise the platform approximately 7 ft / 2.13 m.
 - ⦿ Result: The platform should stop and the tilt alarm will sound at 180 beeps per minute. The platform controls LED readout should display LL and the ground controls LCD should display LL: Machine Tilted.
- 13 Press the drive function button. 
- 14 Press and hold the function enable switch on the control handle.
- 15 Move the control handle in the direction indicated by the blue arrow, then move the control handle in the direction indicated by the yellow arrow.
 - ⦿ Result: The drive function should not work in either direction.
- 16 Lower the platform and remove both pieces of wood.

At the Platform Controls

Test Emergency Stop

- 17 Push in the platform red Emergency Stop button to the off position.
 - ⦿ Result: The engine should shut off and no functions should operate.
- 18 Pull out the red Emergency Stop button to the on position and restart the engine.
 - ⦿ Result: The indicator light should be green.



Test the Horn

- 19 Press the horn button.
 - ⦿ Result: The horn should sound.

Inspections

Test Up/Down Functions and Function Enable

- 20 Start the engine.
- 21 Activate the up/down rocker switch in the direction indicated by the blue arrow.
- ⊙ Result: The platform should not raise.
- 22 Press and hold the lift function enable button.
- 23 Activate the up/down rocker switch in the direction indicated by the blue arrow.
- ⊙ Result: The platform should raise.
- 24 Press and hold the lift function enable button.
- 25 Activate the up/down rocker switch in the direction indicated by the yellow arrow.
- ⊙ Result: The platform should lower. The descent alarm should sound while the platform is lowering.



Test the Steering

Note: When performing the steer and drive function tests, stand in the platform facing the steer end of the machine.

- 26 Press and hold the function enable switch on the control handle.
- 27 Press the thumb rocker switch on top of the control handle in the direction indicated by the blue triangle on the control panel.
- ⊙ Result: The steer wheels should turn in the direction indicated by the blue triangle.
- 28 Press the thumb rocker switch in the direction indicated by the yellow triangle on the control panel.
- ⊙ Result: The steer wheels should turn in the direction indicated by the yellow triangle.

Inspections

Test Drive and Braking

- 29 Press and hold the function enable switch on the control handle.
- 30 Slowly move the drive control handle in the direction indicated by the blue arrow on the control panel until the machine begins to move, then return the handle to the center position.
 - ⦿ Result: The machine should move in the direction that the blue arrow points on the control panel, then come to an abrupt stop.
- 31 Press and hold the function enable switch on the control handle.
- 32 Slowly move the control handle in the direction indicated by the yellow arrow on the control panel until the machine begins to move, then return the handle to the center position.
 - ⦿ Result: The machine should move in the direction that the yellow arrow points on the control panel, then come to an abrupt stop.

Note: The brakes must be able to hold the machine on any slope it is able to climb.

Test Limited Drive Speed

- 33 Press and hold the lift function enable button. Raise the platform approximately 7.5 ft / 2.28 m from the ground.
- 34 Press and hold the function enable switch on the control handle.
- 35 Slowly move the control handle to full drive position.
 - ⦿ Result: The maximum achievable drive speed with the platform raised should not exceed 0.44 ft / 13 cm per second.

If the drive speed with the platform raised exceeds 0.44 ft / 13 cm per second, immediately tag and remove the machine from service.

Inspections

Test Auxiliary Power

- 36 Push and hold the lift function enable button and raise the platform approximately 2 ft / 60 cm.
 - 37 Push in the red Emergency Stop button to shut off the engine.
 - 38 Pull out the red Emergency Stop button to the on position.
 - 39 Press and hold the lift function enable button. Activate the up/down rocker switch in the direction indicated by the yellow arrow.
- ⦿ Result: The platform should lower.

Note: The Emergency Stop button can be pushed when the test is performed.

Test the Outrigger System (if equipped)

- 40 Push and hold the auto level button. 
 - 41 Activate the up/down rocker switch in the down direction.
- ⦿ Result: The outriggers should extend and level the machine. A beep will sound when the machine is level. The indicator lights on the outrigger LED will be green.
- 42 Push and hold the auto level button.
 - 43 Activate the up/down rocker switch in the up direction.
- ⦿ Result: The outriggers should retract and return to the stowed position. The indicator lights on the outrigger LED will be red.

Inspections



Do Not Operate Unless:

- You learn and practice the principles of safe machine operation contained in this operator's manual.
 - 1 Avoid hazardous situations.
 - 2 Always perform a pre-operation inspection.
 - 3 Always perform function tests prior to use.
 - 4 Inspect the workplace.**

Know and understand the workplace inspection before going on to the next section.
 - 5 Only use the machine as it was intended.

Workplace Inspection Fundamentals

The workplace inspection helps the operator determine if the workplace is suitable for safe machine operation. It should be performed by the operator prior to moving the machine to the workplace.

It is the operator's responsibility to read and remember the workplace hazards, then watch for and avoid them while moving, setting up, and operating the machine.

Workplace Inspection Checklist

Be aware of and avoid the following hazardous situations:

- drop-offs or holes
- bumps, floor obstructions, or debris
- sloped surfaces
- unstable or slippery surfaces
- overhead obstructions and high voltage conductors
- hazardous locations
- inadequate surface support to withstand all load forces imposed by the machine
- wind and weather conditions
- the presence of unauthorized personnel
- other possible unsafe conditions

Inspections

Decals Inspection with Words

Determine whether the decals on your machine have words or symbols. Use the appropriate inspection to verify that all decals are legible and in place.

Below is a numerical list with quantities and descriptions.

Part No.	Decal Description	Qty
28158	Label – Unleaded	1
28159	Label – Diesel	1
28160	Label – Liquid Petroleum Gas (1 additional with extra LPG tank option)	1
28174	Label – Power to Platform, 230V	3
28235	Label – Power to Platform, 115V	3
28236	Warning – Improper Operation	1
31060	Danger – Tip-over Hazard, Limit Switch	2
31788	Danger – Explosion/Burn Hazard	1
43618	Label – Directional Arrows	1
44736	Danger – Tip-over Hazard, Tilt Alarm	1
44981	Label – Air Line to Platform	2
52475	Label – Transport Tie-down	4
52494	Caution – Crushing Hazard, Rails	1
52865	Warning – Annual Inspection Record	1
72086	Label – Lifting Point	4
72186	Warning – Crushing Hazard, Outriggers	4
82366	Label – Chevron Rando	1
82418	Ground Control Panel	1
82557	Label – Platform Controls Location	1
82561	Danger – Crushing Hazard	2
82666	Label - Forklift Pocket	4
82793	Instructions – Operating Instructions, Ground	1
97602	Warning – Explosion Hazard	1
97719	Label – Safety Arm	1
114202	Label – Transport Diagram	4
114258	Danger – Explosion Hazard	1
133278	Label – Low Sulfur Fuel (diesel models)	1
214725	Warning – Fall Hazard	1

Part No.	Decal Description	Qty
229427	Label – Outrigger Load	4
229827	Warning – Hot Surface	3
229915	Danger – Outrigger Safety and Instructions	1
230808	Platform Control Panel	1
1263543	Warning – Compartment Access	2
1272843	Instructions – Engine Specifications (GM .998L)	1
1281174	Label – Lanyard Anchorage Point, Fall Arrest/Fall Restrained	6
1293165	Danger – Tip-over, Crush Hazard	1
1294319	Instructions – Kubota Diesel Engine Specs (D1105)	1
1294707	Danger – Electrocution Hazard	3
1295448	Ground Control Panel	1
1298396	Danger – Tip-over, Capacity, GS-2669	1
1298397	Danger – Tip-over, Capacity, GS-3369	1
1298398	Danger – Tip-over, Capacity, GS-4069	1
1299263	Danger – Tip-over, Foam Filled Tires	2
1299364	Label – Scon Software SC050, RT Load Sense	1
1301217	Label – Emergency Lowering	1
1301840	Label – Tip-over Hazard, Platform	1
1305691	Label – Runaway Hazard, GS26	1
1305693	Label – Runaway Hazard, GS33/4069 RT	1
1311471	Label – Danger, Tip, GS69 Foam Filled, Front	2
1319805	Decal, Ground Control Panel, LS	1
1322264	Decal, Ground Control Panel	1
1329783	Instructions – Kubota 1L, Specs	1
T114635	Label – Wheel Load, GS-2669RT	4
T114636	Label – Wheel Load, GS-3369RT	4
T114637	Label – Wheel Load, GS-4069RT	4

■ Shading indicates decal is hidden from view, i.e. under covers

* These decals are model, option or configuration specific.

Inspections

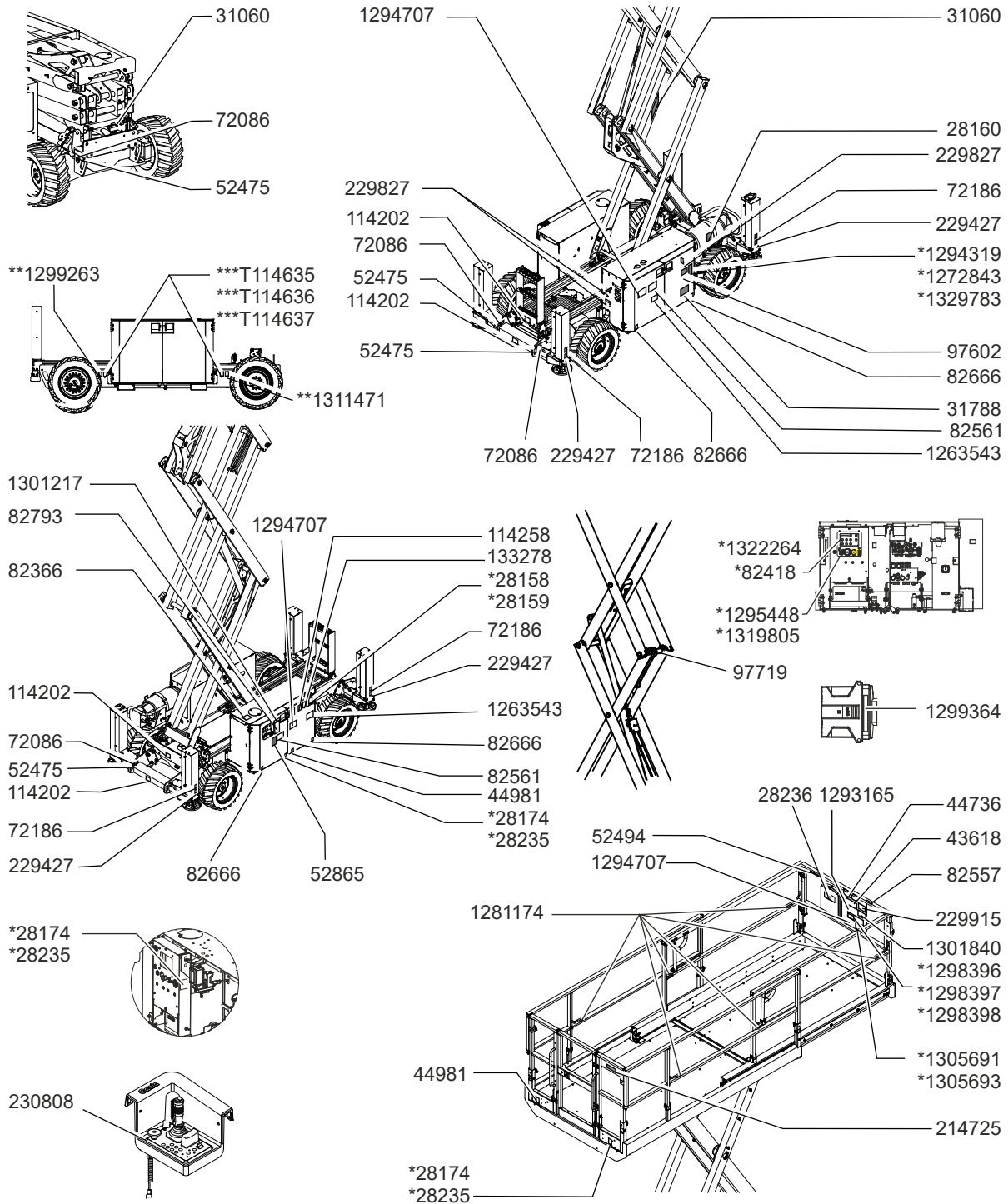

Operating Instructions



Do Not Operate Unless:

- ☑ You learn and practice the principles of safe machine operation contained in this operator's manual.
 - 1 Avoid hazardous situations.
 - 2 Always perform a pre-operation inspection.
 - 3 Always perform function tests prior to use.
 - 4 Inspect the workplace.
 - 5 **Only use the machine as it was intended.**

Fundamentals

The Operating Instructions section provides instructions for each aspect of machine operation. It is the operator's responsibility to follow all the safety rules and instructions in the operator's manual.

Using the machine for anything other than lifting personnel, along with their tools and materials, to an aerial work site is unsafe and dangerous.

Only trained and authorized personnel should be permitted to operate a machine. If more than one operator is expected to use a machine at different times in the same work shift, they must all be qualified operators and are all expected to follow all safety rules and instructions in the operator's manual. That means every new operator should perform a pre-operation inspection, function tests, and a workplace inspection before using the machine.

Operating Instructions

Emergency Stop

Push in the red Emergency Stop button to the off position at the ground controls or the platform controls to stop all machine functions and turn the engine off.

Repair any function that operates when either red Emergency Stop button is pushed in.

Starting the Engine

- 1 At the ground controls, turn the key switch to the desired position.
- 2 Be sure both ground and platform control red Emergency Stop buttons are pulled out to the on position.

Gasoline/LPG models

- 1 Select LPG by pushing the LPG button.
- 2 Press the engine start button.

Note: In cold conditions, 20°F / -6°C and below, the machine should be started on gasoline and warmed for 2 minutes, then switched to LPG. Warm engines can be started on LPG.

Diesel models

- 1 Press the engine start button.

Note: In cold condition, 50°F / 10°C and below, push and hold the glow plug button for 5 to 10 seconds before starting the engine. Limit continuous use of the glow plug button to 20 seconds.

All models

If the engine fails to start after 15 seconds of cranking, determine the cause and repair any malfunction. Wait 60 seconds before trying to start again.

In cold conditions, 20°F/-6°C and below, warm the engine for 5 minutes before operating to prevent hydraulic system damage.

In extreme cold conditions, 0°F/-18°C and below, machines should be equipped with optional cold start kits. Attempting to start the engine when temperatures are below 0°F/-18°C may require the use of a booster battery.

Operating Instructions

Operation from Ground

- 1 Turn the key switch to ground control.
- 2 Pull out both ground and platform red Emergency Stop buttons to the on position.
- 3 Start the engine.

To Position Platform

- 1 Push and hold the lift function enable button.
- 2 Activate the up function or the down function.



Drive and steer functions are not available from the ground controls.

Engine Idle Select

Select the engine idle (rpm) by pressing the idle select button. There are two settings for engine idle:

- Indicator light off: low idle
- Indicator light on: high idle



Operation from Platform

- 1 Turn the key switch to platform control.
- 2 Pull out both ground and platform red Emergency Stop buttons to the on position.
- 3 Start the engine.

To Position Platform

- 1 Push and hold the lift function enable button.
- 2 Activate the up/down rocker switch in the desired direction.



To Steer

- 1 Press and hold the function enable switch on the control handle.
- 2 Turn the steer wheels with the thumb rocker switch located on the top of the control handle.

To Drive

- 1 Press and hold the function enable switch on the control handle.
- 2 Increase speed: Slowly move the control handle off center.

Decrease speed: Slowly move the control handle toward center.

Stop: Return the control handle to center or release the function enable switch.

Use the color-coded direction arrows on the platform controls and the drive chassis to identify the direction the machine will travel.

Machine travel speed is restricted when the platform is raised.

Operating Instructions

Drive Select Button



Machine on incline symbol: Low range operation for inclines.

Indicator Light On Red



If the indicator light is on red, push in and pull out the red Emergency Stop button to reset the system.

If the light stays red, tag and remove the machine from service.

Indicator Light Flashing Red



If the indicator light is flashing red, the platform is overloaded and no functions will operate. An alarm will sound at the platform controls.

Remove weight from the platform.

Push in and pull out the red Emergency Stop button to reset the system.

If the platform is still overloaded, the light will continue to flash.

▲ Driving on a slope

Determine the slope and side slope ratings for the machine and determine the slope grade.

Maximum slope rating, stowed position:



GS-2669RT	40%	22°
GS-3369RT	35%	19°
GS-4069RT	35%	19°

Maximum side slope rating, stowed position:



GS-2669RT	40%	22°
GS-3369RT	35%	19°
GS-4069RT	35%	19°

Note: Slope rating is subject to ground conditions with one person in the platform and adequate traction. Additional platform weight may reduce slope rating.

Operating Instructions

To determine the slope grade:

Measure the slope with a digital inclinometer OR use the following procedure.

You will need:

- carpenter's level
- straight piece of wood, at least 3 feet/1 m long
- tape measure

Lay the piece of wood on the slope.

At the downhill end, lay the level on the top edge of the piece of wood and lift the end until the piece of wood is level.

While holding the piece of wood level, measure the vertical distance from the bottom of the piece of wood to the ground.

Divide the tape measure distance (rise) by the length of the piece of wood (run) and multiply by 100.

Example:

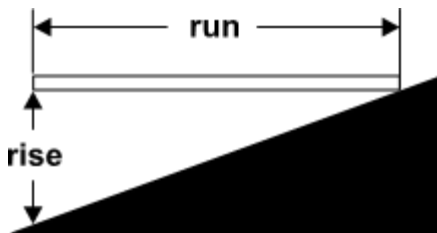

Piece of wood = 144 inches (3.6 m)

Run = 144 inches (3.6 m)

Rise = 12 inches (0.3 m)

$12 \text{ in} \div 144 \text{ in} = 0.083 \times 100 = 8.3\% \text{ grade}$

$0.3 \text{ m} \div 3.6 \text{ m} = 0.083 \times 100 = 8.3\% \text{ grade}$

If the slope exceeds the maximum slope or side slope rating, then the machine must be winched or transported up or down the slope. See Transport and Lifting section.

To Extend and Retract Platform

- 1 Lift the platform extension lock handles to the horizontal position.
- 2 Push the platform extension lock handles to extend the platform to the desired position.

Do not stand on the platform extension while trying to extend it.

- 3 Lower the platform extension lock handles and make sure the extension deck is locked.

Platform Overload

If the platform controls displays a flashing red light and the ground controls LCD diagnostic readout displays OL: Platform Overloaded, the platform is overloaded and no functions will operate. An alarm will sound.

- 1 Push in the Red Emergency stop button to the off position.
- 2 Remove weight from the platform.
- 3 Pull out the Red Emergency Stop button to the on position.



LCD Readout

Operating Instructions

Auxiliary Power

At the Ground Controls

Push and hold the lift function enable button and activate the down function.

In the event of a power failure, use the Auxiliary Lowering function enable button and the Auxiliary Lowering down button.

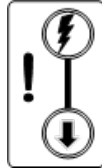

At the Platform Controls

Push and hold the lift function enable button and activate the up/down rocker switch in the down direction.

Operation from Ground with Controller

Maintain safe distances between the operator, machine and fixed objects.

Be aware of the direction the machine will travel when using the controller.

Outrigger Operation (if equipped)

- 1 Position the machine below the desired work area.

Note: The engine must be running for the outriggers to operate.

- 2 Push and hold the auto level button.



- 3 Activate the up/down rocker switch in the down direction. The outriggers will extend and level the machine. A beep will sound when the machine is level.

The indicator light on the lift function enable button will turn red when one but not all outriggers are down. All drive and lift functions are disabled.



The light turns green on the lift function enable button and on the individual outrigger buttons when all the outriggers are in firm contact with the ground.

The drive function is disabled while the outriggers are down.

Operating Instructions

Tilt Sensor Activation Settings

Tilt Sensor Activation Settings	
Chassis Angle on Wheels	
Chassis Angle (side to side)	2°
Chassis Angle (front to back)	3°
Chassis Angle on Outriggers	
Chassis Angle (side to side)	0.8°
Chassis Angle (front to back)	3°

When the machine is On Incline and elevated above the down limit height, the tilt alarm sounds and the drive and lift functions are disabled.



Lower the machine below the down limit height to restore drive and lift functionality.



Return the machine to level ground to restore lift functions.

After Each Use

- 1 Select a safe parking location—firm level surface, clear of obstruction and traffic.
- 2 Lower the platform.
- 3 Turn the key switch to the off position and remove the key to secure from unauthorized use.

Transport and Lifting Instructions



Observe and Obey:

- ☑ Genie provides this securement information as a recommendation. Drivers are solely responsible for making sure machines are properly secured and the correct trailer is selected.
- ☑ Genie customers needing to containerize any lift or Genie product should source a qualified freight forwarder with expertise in preparing, loading and securing construction and lifting equipment for international shipment.
- ☑ Only qualified mobile elevating work platform operators should move the machine on or off the truck.
- ☑ The transport vehicle must be parked on a level surface.
- ☑ The transport vehicle must be secured to prevent rolling while the machine is being loaded.
- ☑ Be sure the vehicle capacity, loading surfaces and chains or straps are sufficient to withstand the machine weight. Genie lifts are very heavy relative to their size. See the serial label for the machine weight.
- ☑ If the slope of the transport vehicle bed exceeds the maximum slope rating, the machine must be loaded and unloaded using a winch as described in the brake release operation.

Free-wheel Configuration for Winching

Chock the wheels to prevent the machine from rolling.

4WD models: Release the wheel brakes by turning over the two rear torque hub disconnect caps. Turn needle valve on traction manifold counter-clockwise until it stops.

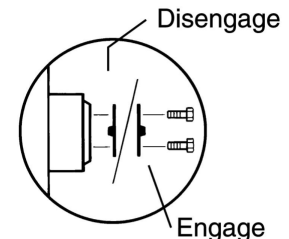

Be sure the winch line is properly secured to the drive chassis tie points and the path is clear of all obstructions.

Reverse the procedures described to re-engage the brakes.

Note: The needle valve should always remain closed during normal operation.

Transport and Lifting Instructions

Securing to Truck or Trailer for Transit

Always chock the machine wheels in preparation for transport.

Retract and secure the extension deck.

Use the tie-down points on the chassis for anchoring down to the transport surface.

Use a minimum of 2 chains or straps.

Use chains or straps of ample load capacity.

Turn the key switch to the off position and remove the key before transporting.

Inspect the entire machine for loose or unsecured items.

If the railings have been folded down, secure them with straps before transporting.

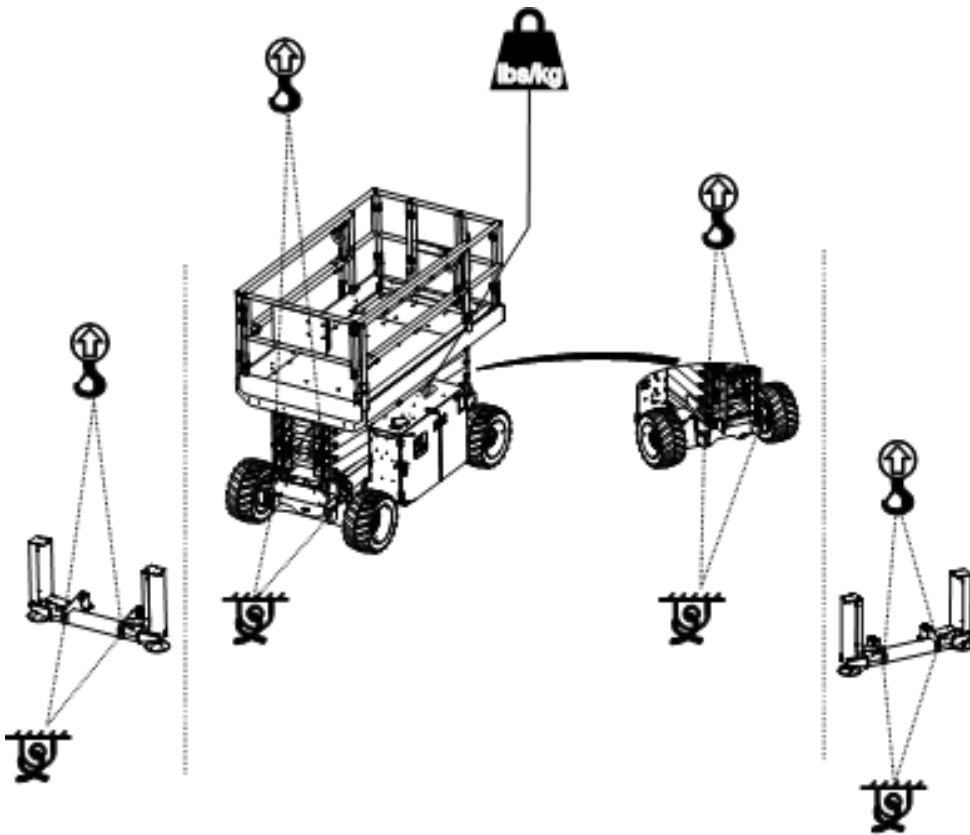

Transport and Lifting Instructions



Observe and Obey:

- ☑ Only qualified riggers should rig and lift the machine.
- ☑ Be sure the crane capacity, loading surfaces and straps or lines are sufficient to withstand the machine weight. See the serial label for the machine weight.

Lifting Instructions

Fully lower the platform. Be sure the extension deck, controls and component trays are secure. Remove all loose items on the machine.

Determine the center of gravity of your machine using the table and the picture on this page.

Attach the rigging only to the designated lifting points on the machine.

Adjust the rigging to prevent damage to the machine and to keep the machine level.

Center of gravity	X Axis	Y Axis
GS-2669RT without outriggers	42.5 in 108.01 cm	30.9 in 78.5 cm
GS-3369RT without outriggers	42.6 in 108.2 cm	31.4 in 79.8 cm
GS-4069RT without outriggers	38.8 in 98.6 cm	31.1 in 79.0 cm
GS-2669RT with outriggers	42.7 in 108.5 cm	30.1 in 76.5 cm
GS-3369RT with outriggers	42.8 in 109 cm	30.6 in 78 cm
GS-4069RT with outriggers	39.2 in 100 cm	30.5 in 78 cm

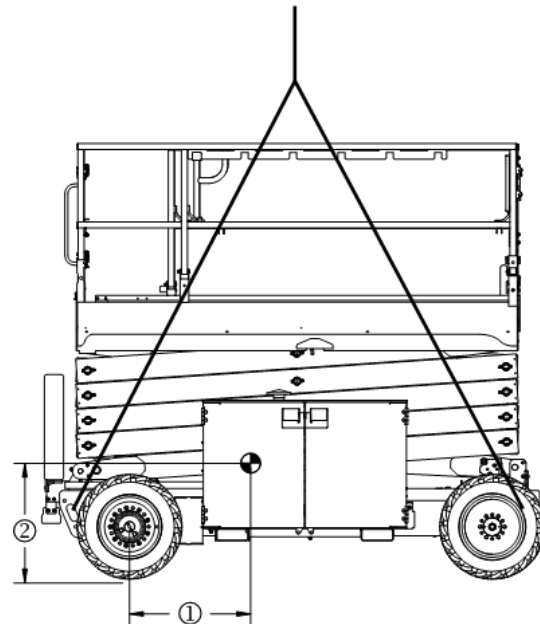

1 = X Axis

2 = Y Axis

Maintenance



Observe and Obey:

- Only routine maintenance items specified in this manual shall be performed by the operator.
- Scheduled maintenance inspections shall be performed by qualified service technicians, according to the manufacturer's specifications.

Maintenance Symbols Legend

The following symbols have been used in this manual to help communicate the intent of the instructions. When one or more of the symbols appear at the beginning of a maintenance procedure, it conveys the meaning below.



Indicates that tools will be required to perform this procedure.



Indicates that new parts will be required to perform this procedure.



Indicates that a cold engine is required before performing this procedure.

Check the Engine Oil Level



Maintaining the proper engine oil level is essential to good engine performance and service life. Operating the machine with an improper oil level can damage engine components.

Note: Check the oil level with the engine off.

- 1 Check the oil level dipstick. Add oil as needed.

Kubota D-1105 Engine

Oil type	SAE10W or 10W-30
----------	------------------

GM (PSI) .998L Engine

Oil type	15W-40
----------	--------

Kubota DF WG-972-E4 Engine

Oil type	SAE 20 or SAE 10W-30 SAE 15W-40
----------	------------------------------------

Oil type - Cold Conditions	SAE10W or 10W-30
----------------------------	------------------

Maintenance

Diesel Fuel Requirements



Satisfactory engine performance is dependent on the use of a good quality fuel. The use of a good quality fuel will give the following result: long engine life and acceptable exhaust emissions levels.

Minimum diesel fuel requirements for each engine are listed below.

Kubota D-1105 Engine	
Fuel Type	Low Sulfur Diesel (LSD)

Check the Hydraulic Oil Level



Maintaining the hydraulic oil at the proper level is essential to machine operation. Improper hydraulic oil levels can damage hydraulic components. Daily checks allow the inspector to identify changes in oil level that might indicate the presence of hydraulic system problems.

- 1 Be sure that the platform is in the stowed position and the engine off.
- 2 Visually inspect the sight gauge located on the side of the hydraulic oil tank.
- ⊙ Result: The hydraulic oil level should be within the top 2 inches / 5 cm of the sight gauge.
- 3 Add oil as needed. Do not overfill.

Hydraulic oil specifications

Hydraulic oil type	Chevron Rando HD equivalent
--------------------	-----------------------------

Maintenance

Check the Batteries



Proper battery condition is essential to good machine performance and operational safety. Improper fluid levels or damaged cables and connections can result in component damage and hazardous conditions.

- ▲ **Electrocution hazard.** Contact with hot or live circuits may result in death or serious injury. Remove all rings, watches and other jewelry.
- ▲ **Bodily injury hazard.** Batteries contain acid. Avoid spilling or contacting battery acid. Neutralize battery acid spills with baking soda and water.

Note: Perform this test after fully charging the batteries.

- 1 Put on protective clothing and eye wear.
- 2 Be sure that the battery cable connections are tight and free of corrosion.
- 3 Be sure that the battery hold-down brackets are in place and secure.

Note: Adding terminal protectors and a corrosion preventative sealant will help eliminate the corrosion on the battery terminals and cables.

Check the Engine Coolant Level



Maintaining the engine coolant at the proper level is essential to engine service life. Improper coolant level will affect the engine's cooling capability and damage engine components. Daily checks will allow the inspector to identify changes in coolant level that might indicate cooling system problems.

- 1 Check the fluid level in the coolant recovery tank. Add fluid as needed.
- ▲ **Bodily Injury Hazard.** Fluids in the radiator are under pressure and extremely hot. Use caution when removing cap and adding fluids.

Maintenance

Scheduled Maintenance

Maintenance performed quarterly, annually and every two years must be completed by a person trained and qualified to perform maintenance on this machine according to the procedures found in the service manual for this machine.

Machines that have been out of service for more than three months must receive the quarterly inspection before they are put back into service.

Obey all local and governmental regulations regarding the disposal and decommissioning of the machine at the end of its lifetime. Refer to the appropriate Genie service manual for additional information.

Specifications

GS-2669RT

Height, working maximum	32 ft	9.8 m
Height, platform maximum	26.2 ft	8 m
Height, stowed maximum, rails up	102 in	2.59 m
Height, stowed maximum, rails lowered	75.5 in	1.92 m
Height, guard rails	58 in	1.47 m
Width	69 in	1.75 m
Length, platform retracted	123 in	3.12 m
Length, platform retracted, models with outriggers	148 in	3.76 m
Length, platform extended	177.5 in	4.51 m
Length, platform extended, models with outriggers	189.5 in	4.81 m
Length, outside platform extended	170 in	4.32 m
Maximum load capacity	1500 lbs	680 kg
Maximum wind speed	28 mph	12.5 m/s
Wheelbase	90 in	2.29 m
Turning radius (outside)	181.2 in	4.6 m
Turning radius (inside)	83 in	2.11 m
Ground clearance	9½ in	24 cm
Weight	7295 lbs	3309 kg

(Machine weights vary with option configurations. See serial label for specific machine weight.)

Controls	Proportional
AC outlet in platform	Standard

Platform dimensions

Platform length x width	110 in x 63 in	2.79 x 1.6 m
Platform extension length	105 in	2.67 m

Drive speeds

Stowed, maximum	3.5 mph	5.63 km/h
Platform raised, maximum	0.3 mph 40 ft/90 sec	0.48 km/h 12.2 m/90 sec
Maximum hydraulic pressure (functions)	3500 psi	241 bar
Tire size	26x12D380	

Maximum side slope rating, stowed position 40% (22°)

Maximum slope rating, stowed position 40% (22°)

Note: Slope rating is subject to ground conditions with one person in the platform and adequate traction. Additional platform weight may reduce slope rating.

Maximum allowable chassis inclination Refer to "Tilt Sensor Activation Settings" section

Floor loading information

Tire load maximum	2840 lbs	1288 kg
Outrigger load, maximum	2840 lbs	1288 kg
Tire contact pressure	71.9 psi	5.06 kg/cm ² 496 kPa
Outrigger contact pressure	36.8 psi	2.59 kg/cm ² 254 kPa
Occupied floor pressure	173 psf	846 kg/m ² 8.3 kPa

Note: Floor loading information is approximate and does not incorporate different option configurations. It should be used only with adequate safety factors.

Ambient operating temperature -20° F to 120° F
-29° C to 49° C

Continuous improvement of our products is a Genie policy. Product specifications are subject to change without notice or obligation.

Specifications

GS-3369RT

Height, working maximum	39 ft	11.9 m
Height, platform maximum	32.67 ft	10 m
Height, stowed maximum, rails up	102 in	2.59 m
Height, stowed maximum, rails lowered	75.5 in	192 m
Height, guard rails	58 in	1.47 m
Width	69 in	1.75 m
Length, platform retracted	123 in	3.12 m
Length, platform retracted, models with outriggers	148 in	3.76 m
Length, platform extended	177.5 in	4.51 m
Length, platform extended, models with outriggers	189.5 in	4.81 m
Length, outside platform extended	170 in	4.32 m
Maximum load capacity	1000 lbs	454 kg
Maximum wind speed	28 mph	12.5 m/s
Wheelbase	90 in	2.29 m
Turning radius (outside)	181.2 in	4.6 m
Turning radius (inside)	83 in	2.11 m
Ground clearance	9½ in	24 cm

Weight 7695 lbs 3490 kg

(Machine weights vary with option configurations. See serial label for specific machine weight.)

Controls	Proportional
AC outlet in platform	Standard

Platform dimensions

Platform length x width	110 in x 63 in	2.79 x 1.6 m
Platform extension length	105 in	2.67 m

Drive speeds

Stowed, maximum	3.5 mph	5.63 km/h
Platform raised, maximum	0.3 mph 40 ft/90 sec	0.48 km/h 12.2 m/90 sec
Maximum hydraulic pressure (functions)	3500 psi	241 bar
Tire size	26x12D380	

Maximum slope rating, stowed position 35% (19°)

Maximum side slope rating, stowed position 35% (19°)

Note: Slope rating is subject to ground conditions with one person in the platform and adequate traction. Additional platform weight may reduce slope rating.

Maximum allowable chassis inclination Refer to "Tilt Sensor Activation Settings" section

Floor loading information

Tire load maximum	3058 lbs	1387 kg
Outrigger load, maximum	3058 lbs	1387 kg
Tire contact pressure	76.1 psi	5.35 kg/cm ² 524 kPa
Outrigger contact pressure	38.9 psi	2.74 kg/cm ² 268 kPa
Occupied floor pressure	172 psf	838 kg/m ² 8.22 kPa

Note: Floor loading information is approximate and does not incorporate different option configurations. It should be used only with adequate safety factors.

Ambient operating temperature -20° F to 120° F
-29° C to 49° C

Continuous improvement of our products is a Genie policy. Product specifications are subject to change without notice or obligation.



Specifications

GS-4069RT

Height, working maximum	46 ft	14 m
Height, platform maximum	40.25 ft	12.3 m
Height, stowed maximum, rails up	108 in	2.74 m
Height, stowed maximum, rails lowered	82 in	2.08 m
Height, guard rails	58 in	1.47 m
Width	69 in	1.75 m
Length, platform retracted	123 in	3.12 m
Length, platform retracted, models with outriggers	148 in	3.76 m
Length, platform extended	177.5 in	4.51 m
Length, platform extended, models with outriggers	189.5 in	4.81 m
Length, outside platform extended	170 in	4.32 m
Maximum load capacity	800 lbs	363 kg
Maximum wind speed	28 mph	12.5 m/s
Wheelbase	90 in	2.29 m
Turning radius (outside)	181.2 in	4.6 m
Turning radius (inside)	83 in	2.11 m
Ground clearance	9½ in	24 cm

Weight 10,320 lbs 4681 kg

(Machine weights vary with option configurations. See serial label for specific machine weight.)

Controls	Proportional
AC outlet in platform	Standard

Platform dimensions

Platform length x width	110 in x 63 in	2.79 x 1.6 m
Platform extension length	105 in	2.67 m

Drive speeds

Stowed, maximum	3.5 mph	5.63 km/h
Platform raised, maximum	0.3 mph 40 ft/90 sec	0.48 km/h 12.2 m/90 sec
Maximum hydraulic pressure (functions)	3500 psi	241 bar
Tire size	26x12D380	

Maximum slope rating, stowed position 35% (19°)

Maximum side slope rating, stowed position 35% (19°)

Note: Slope rating is subject to ground conditions with one person in the platform and adequate traction. Additional platform weight may reduce slope rating.

Maximum allowable chassis inclination Refer to "Tilt Sensor Activation Settings" section

Floor loading information

Tire load maximum	3816 lbs	1731 kg
Outrigger load, maximum	3816 lbs	1731 kg
Tire contact pressure	94.9 psi	6.68 kg/cm ² 654 kPa
Outrigger contact pressure	48.3 psi	3.42 kg/cm ² 335 kPa
Occupied floor pressure	214 psf	1045 kg/m ² 10.25 kPa

Note: Floor loading information is approximate and does not incorporate different option configurations. It should be used only with adequate safety factors.

Ambient operating temperature -20° F to 120° F
-29° C to 49° C

Continuous improvement of our products is a Genie policy. Product specifications are subject to change without notice or obligation.

www.genielift.com

Distributed By: